

Fall 1999

Interweave

Knits

EXCLUSIVE
pattern from
Icelandic Design

SNEAK
PREVIEWS
of 3 new
knitting books

A STAR Knitter
in **HOLLYWOOD**



\$5.95 U.S. \$7.50 CANADA



0 70989 37268 9

**From the heartland of America,
comes the country's finest yarns.**

We are your American yarn company.

When reaching for excellence, reach for Brown Sheep yarn.
We offer fine fibers, rich colors, and luxurious textures.

For a dealer nearest you visit us at:

www.brownsheep.com

or call at: 308-635-2198

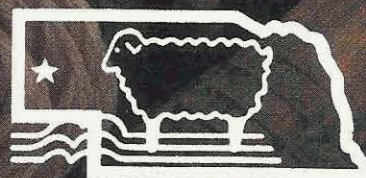

Brown Sheep Company, Inc.

Dept K2-99 • 100662 County Rd. 16
Mitchell, NE 69357

Interweave Knits

FALL 1999
VOLUME IV, NUMBER 3

Features & Projects

- 14 **Icelandic Design: Growing a Business** MARILYN MURPHY
- 17 **Aztec Daisy Cardigan** ICELANDIC DESIGN
- 22 **Maghrib Vests** SANDY CUSHMAN
- 26 **The Sanquhar** DONNA KAY
- 30 **Folk Knitting in Estonia** NANCY BUSH
- 31 **Estonian-Inspired Pocket Bag** NANCY BUSH
- 36 **Hungarian Rhapsody** HEATHER LODINSKY
- 40 **Irish Diamond Shawl** CHERYL OBERLE
- 44 **Bavarian Twisted-Stitch Cardigan** MEG SWANSEN
- 50 **Medallion Kimono Jacket** NORIKO SEKIGUCHI
- 54 **Aran Duffle Coat** JUDITH L. SWARTZ
- 58 **13 Ways to Color a Kimono** COLLEEN DAVIS
- 64 **Andhra Pradesh Vest** DIANE ZANGL
- 68 **Petroglyph** JILL WOLCOTT
- 73 **Ute Socks** NANCY BUSH
- 82 **A World of Mittens** STAFF PROJECT

FRONT COVER: *Hungarian Rhapsody*

Departments

- 2 **Strands**
FROM THE EDITOR
- 4 **Cables**
LETTERS FROM OUR READERS
- 6 **Glossary**
- 10 **Beyond the Basics**
CENTERING COLOR PATTERNS
DOROTHY T. RATIGAN
- 12 **Oops!**
- 76 **Connections**
KNITTING IN THE FAST LANE
KATARINA LINDELL VOLL
- 80 **Folklore**
THE GØTA PHOTO:
TALKING TO HARGARÐ TVÓRFOSS
ROBIN HANSEN
- 85 **Product News**
JUDITH L. SWARTZ
- 86 **Sources for Supplies**
- 95 **Advertisers' Index**
- 96 **Ravelings**
REDISCOVERING INTARSIA IN THE ROUND
DEANNA TOBIN

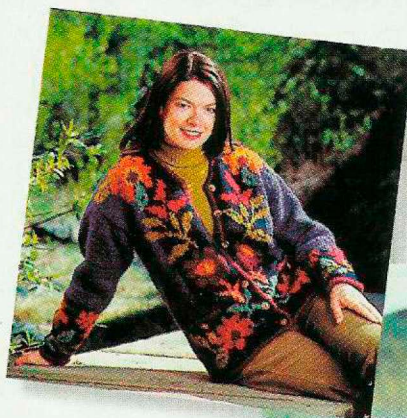

Aztec Daisy Cardigan
page 17

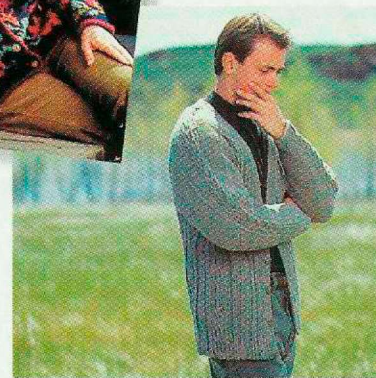

Bavarian Twisted-Stitch Cardigan
page 44

STRANDS

FROM THE EDITOR



THIS ISSUE pulls together much of what inspires me—global textiles, others' creativity, and the fall season. Textiles are my passion; I've collected them for years. Textiles from India, Indonesia, Africa, South America, Japan, and the Pacific Islands blend with the contemporary art in my home. I wonder at every technique the artisans have employed and fantasize about their daily lives.

The designers in this issue have done a similar thing. They have interpreted cultural influences in inspiring shapes, used stitch-pattern combinations in intriguing ways, translated folklore into knitting, and on and on. It's a wonderful pairing of creativity and culture.

Combining all this inspiration with the fall season when we're ready to pull out our needles and yarn again is the best link of all. Fall always presents a transition point for me, with its roots in "going back to school" with new uniforms, books, and friends. As an adult, sweaters have become my uniform, books are a constant, and the excitement of establishing new friendships remains.

Right now, the friendship aspect holds my attention. This is my last issue as editor of *Interweave Knits*. I am not leaving Interweave Press, only changing my role to editorial director. Over the last three years, many friendships have formed among the

staff of this magazine and *Knits News*. *Interweave Knits* grew as a result of the dedication of the team that formed and nurtured it. To acknowledge their contributions is hardly enough—what they have brought to me is beyond words and deeply felt. I thank each and every one of them. And I thank each of you for your passionate interest in this craft that brings us all together.

With departures come arrivals and we are thrilled to announce that, starting with the Winter issue, Melanie Falick, author of *Knitting in America* (Artisan, 1997) and *Kids Knitting* (Artisan, 1998), is taking the reins as editor. Melanie has very rich plans for the magazine and I'm excited for her. Ann Budd is stepping up to be managing editor, Judith Durant is in the enviable position of

becoming a freelance book editor, Dot Ratiagan remains as our knowledgeable technical editor, and the rest of our team will continue to do the superb job they always do.

We are all so fortunate to have knitting in our lives; being able to share it with others is even more satisfying. But how can we extend the world of knitting? The Craft Yarn Council of America (CYCA) sponsored a Knit-Out last year in New York City, and it's planned again for this fall. Expanded to Knit-Out—Crochet Too '99, the event will be held at New York's Union Square, Sunday, October 24, from noon to 5:00 P.M. It will kick off a week of activities with knitting and crocheting enthusiasts demonstrating their crafts in public forums nationwide. We encourage you to talk to your local guild or knitting shop about organizing an extension activity for knitting or crochet. For more information about the event or about the CYCA, visit their website at www.craftyarncouncil.com or call (704) 824-7838.

I look forward to seeing many of you at upcoming conferences and shows. Until then, may the bonds of friendship continue to grow as more people cast on to the knitting circle.

Marilyn Murphy

In the next **Knits**

Extra-Special Gifts

Socks, hats, throws, sweaters, and more
In wool, cotton, cashmere, and silk

EDITORIAL

CREATIVE DIRECTOR Linda C. Ligon EDITORIAL DIRECTOR Marilyn Murphy EDITOR Marilyn Murphy ASSOCIATE EDITOR Judith Durant ASSISTANT EDITOR Ann Budd
PRODUCTION EDITOR Mona Pompili TECHNICAL EDITOR Dorothy T. Ratiagan EDITORIAL ASSISTANT Amy C. Clarke COPY EDITOR Stephen Beal

PUBLISHING

PUBLISHER Ceri Anderson ASSOCIATE PUBLISHER Suzanne DeAtley MARKETING MANAGER Jennifer Nasli OPERATIONS MANAGER Eric Redding
ADVERTISING Sharon Altergott CIRCULATION MANAGER Jenny Fish SUBSCRIPTION SERVICE Donna Melton

ART & PRODUCTION

DESIGN Jason Reid, Elizabeth R. Mrofka PRODUCTION MANAGER Marc McCoy Owens PRODUCTION COORDINATOR Andy Webber
ILLUSTRATION Gayle Ford, Susan Strawn Bailey PHOTOGRAPHY Joe Coca PHOTOGRAPHIC ASSISTANT Lisa Rabold

Interweave Knits (ISSN 1088-3622) is published quarterly by Interweave Press, Inc., 201 E. Fourth St., Loveland, CO 80537-5655. Phone (970) 669-7672. Fax (970) 667-8317.

USPS #017-249. Periodicals postage paid at Loveland, CO 80538, and additional mailing offices. Subscription rate is \$24/one year in the U.S., \$31/one year in Canada and foreign countries (surface delivery) U.S. funds only. POSTMASTER: Please send address change to *Interweave Knits*, 201 E. Fourth St., Loveland, CO 80537-5655.

Interweave Knits is copyrighted © 1999 by Interweave Press, Inc. All rights reserved. Reproduction in whole or in part is prohibited, except by permission of the publisher.

Printed in the USA. For subscription information, call (800) 645-3675. Visit the Interweave Press website at www.interweave.com.

Our e-mail address is knits@interweave.com.

INTERWEAVE PRESS

Distributed by WARNER PUBLISHER SERVICES
A TIME WARNER COMPANY

ROVINGS

Custom Carding and Dyeing of
fine wools and exotic fibres.

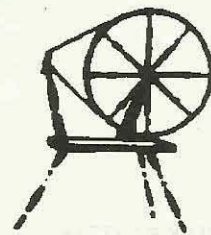

SILKS! ALPACA! ANGORA! KID MOHAIR!

These exotic fibres are blended with Prime
Australian Polwarth wool into 6 luxurious yarns.

42 Gorgeous hand-dyed colours.

We colour match to your specifications.

Polwarth and Polwarth blend yarns—
Hand-dyed or natural colors.

**Price list available upon request.
Sample cards \$10.00**

**Shop Hours: Tuesday - Friday 10:00 - 5:00 (CST)
Saturday 10:00 - 1:00**

**Box 192 Oakbank, MB Canada R0E 1J0
1-800-266-5536
fax: 1-204-222-6129**

**Visa/MC accepted
Prices are in Canadian Dollars**

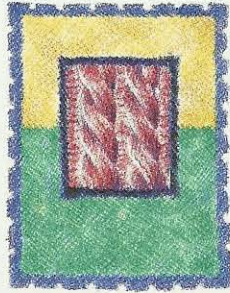

CHARITY KNITTING

I'm deeply touched by Myrna Stahman's Matthew and Matt scarves in the last *Knits News*. To knit and pass on a thing of beauty can help us get through the horrors of life. I've been deeply gratified by Hats with Hugs. I just knitted one in double-ply unspun Icelandic wool for an ill relative.

—Mazie Kassim
El Paso, Texas

WHAT A HOOT

Each issue I look to the staff project with giddy excitement. What, I wonder, did they think up this time? I'm always entertained. Do you *really* knit all those projects yourselves? I have this wonderful mental image of you all sitting with your feet up on your desks while you knit. I should have such fun at my job!

—Maggie Lancaster
Des Moines, Iowa

We do indeed knit all our projects, but to different degrees of completion (note the number of single mittens on page 82). And while you won't find us at our desks knitting (there is a magazine to produce, after all), you will find many of us knitting at the lunch table on any given day.

THERE'S A LOT TO LEARN

I have just begun a subscription and really like the format of your magazine. You offer more than just a collection of patterns; you give readers an opportunity to learn new things. I especially like "Beyond the Basics" and articles that explore a technique in detail. I applaud your efforts.

—Hao Chang
Arlington, Massachusetts

Thanks for the praise, Hao. We're working hard to give you more of what you like in each issue.

A KINDRED SPIRIT

I had tears in my eyes after reading "Ravelings" by Jennifer Nastu in the Summer '99 issue! I, too, have only been knitting for a short time and am an obsessive knitter. I knit at stop lights and birthday parties. I knit waiting for my kids at preschool and at concerts. I do "escapist" knitting, "reluctant" knitting, "panic" knitting, and "challenge" knitting. I thought no one would ever understand my knitting compulsion, until now. I have a kindred spirit and am not alone. Thank you!

—Sandra Carter
Long Beach, California

MORE ON DARNING

I am writing in response to the article, "Darn! There's a Hole in My Sock!" by Beth Brown-Reinsel (Winter '98). Darning, mending, and altering clothes were very necessary parts of life in my childhood during World War II in Germany.

My father (a seaman in his early years) knitted socks using a set of filed-down bicycle spokes and wool he had spun himself. The legs of the socks were knitted in a k3, p3 rib and the foot in stockinette stitch. He did his own darning, and just for fun would sometimes use colored wool for the darns, eventually ending up with "polka-dot" socks. If the foot wore out, he would cut it off at the leg and reknit it, thereby using the legs over and over to create "new" socks.

When my father died in 1983 there were forty pairs of handknit socks in his house. He lived alone for many years after

the early death of my mother, and would knit and spin to while away the long and lonely evening hours in her absence.

—Inga Peerson
East Geelong, Victoria, Australia

A WORD OF THANKS

I've been a subscriber for a couple of years now and want to say how helpful I find the "Glossary." The drawings are clear and beautiful. Please extend my appreciation to your illustrator.

—Rachel Thomas
Nashville, Tennessee

We have Gayle Ford and Susan Strawn Bailey to thank for those great drawings. Not only is the quality of their work consistently high, they always meet deadlines with time to spare!

FIRST KNITTING PROJECT

I've wanted to teach my seven-year-old daughter how to knit for some time. After seeing "Critters Kids Can Knit" by Theresa Baker in the Summer '99 issue, I decided to take the plunge. My daughter loves ladybugs and I happened to have some red wool and size 10 needles on hand. In less than an hour, she needed my help with only the first stitch of each row. She finished the square the next day! Now she's working on a yellow turtle and is already making plans for a gray bunny.

The experience reminded me of when my mother taught me to knit and how proud she was of my every stitch. I hope my daughter will take the same pleasure in teaching her own daughter to knit someday.

—Laura Cort
San Francisco, California

We welcome your comments and questions. Write to "Cables," Interweave Knits, 201 E. Fourth St., Loveland, CO 80537-5655; fax (970) 669-6117; e-mail knits@interweave.com.

NEW BOOKS FROM INTERWEAVE PRESS

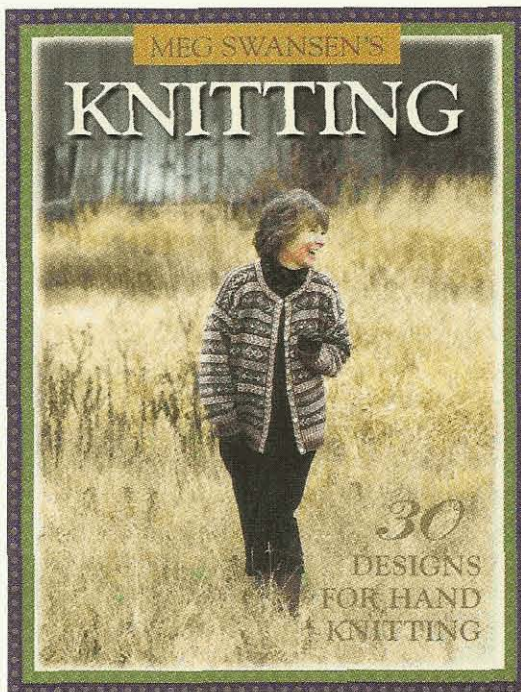

Meg Swansen's Knitting

30 Designs for Hand Knitting

By Meg Swansen

Knitting guru Meg Swansen shares tips, tricks, and techniques she's learned during her long knitting and designing career. Her original designs include instructions and charts for 22 sweaters, 3 vests, and 4 fitted-arch socks, each rendered in four-color fashion photography taken on-site at the Swansen home and studio in Wisconsin.

9 × 12, clothbound, 144 pages, color photos, line drawings and charts. \$39.95 + s&h

Available in September!

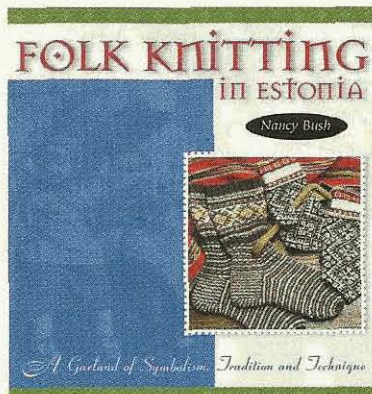

Folk Knitting in Estonia

A Garland of Symbolism, Tradition, and Technique

By Nancy Bush

Folk Knitting in Estonia explores the fascinating history of the craft and the country. You will find clearly illustrated, step-by-step instructions for 25 gloves, mittens, and socks, both historic and contemporary, using traditional patterns typical to Estonian knitting.

Available in November!

8½ × 9, paperbound, 120 pages, color and b&w photos, line drawings and charts. \$21.95 + s&h

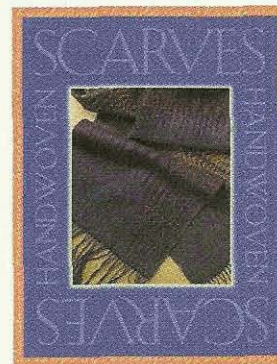

Handwoven Scarves

From the editors at Interweave Press

This inspirational book is an exquisite collection of 50 handwoven scarves from 25 contemporary, nationally-known weavers. Each scarf is portrayed in a full-page, full-color photograph, along with a biography of the weaver, draft of the weave structure, and design notes.

Available in October!

8½ × 11, paperbound, 112 pages, color photos, and charts. \$24.95 + s&h



Nicky Epstein's Knitted Embellishments

350 Appliqués, Borders, Cords and More!

By Nicky Epstein

Step-by-step instructions for 350 embellishments are easy to follow and include line drawings, charts, and color photos. Here you'll find appliquéd flowers, leaves, fruits, and vegetables. Fringes, tassels, pom-poms, and ties. Cords, motifs, mock cables, frogs, and closures.

Available Now!

8½ × 9, softbound, 276 pages, 350 color photos. \$31.95 + s&h



800-645-3675.

Find these books at your favorite craft source or call Dept. A-K1 at **800-645-3675**.
Interweave Press 201 E. Fourth St. Loveland, CO 80537-5655 www.interweave.com

GLOSSARY

ABBREVIATIONS

beg	beginning; begin; begins
bet	between
BO	bind off
CC	contrasting color
cm	centimeter(s)
cn	cable needle
CO	cast on
cont	continue
dec(s)	decrease(s); decreasing
dpn	double-pointed needle(s)
fol	following
fwd	forward
g	gram(s)
inc	increase; increasing
k	knit
k1f&b	knit into front and back of same st
k2tog	knit two stitches together
kwise	knitwise
LC	left cross
m(s)	marker(s)
MC	main color
mm	millimeter(s)
M1	make one
p	purl
p1f&b	purl into front and back of same st
p2tog	purl two stitches together
patt(s)	pattern(s)
pm	place marker
psso	pass slip stitch over
pwise	purlwise
RC	right cross
rem	remaining
rep	repeat
rev St st	reverse stockinette stitch
rib	ribbing
rnd(s)	round(s)
RS	right side
rev sc	reverse single crochet
sc	single crochet
sk	skip
skp	slip 1, k1, psso
sl	slip
sl st	slip stitch (sl 1 st pwise unless otherwise indicated)
ssk	slip 1 kwise, slip 1 kwise, k2 sl sts tog tbl
ssp	slip 1 kwise, slip 1 kwise, p2 sl sts tog tbl
st(s)	stitch(es)
St st	stockinette stitch
tbl	through back loop
tog	together
WS	wrong side
wyb	with yarn in back
wyf	with yarn in front
yo	yarn over
*	repeat starting point (i.e., repeat from *)
**	repeat all instructions between asterisks
()	alternate measurements and/or instructions
[]	instructions that are to be worked as a group a specified number of times

Knitting Gauge

To check gauge, cast on 30 to 40 stitches using the recommended needle size. Work in pattern stitch until the piece measures at least 4" (10 cm) from the cast-on edge. Remove the swatch from the needles or bind off loosely, and lay the swatch on a flat surface. Place a ruler over the swatch and count the number of stitches across and number of rows down (including fractions of stitches and rows) in 4" (10 cm). Repeat two or three times on different areas of the swatch to confirm your measurements. If you have more stitches and rows than called for in the instructions, use larger needles; if you have fewer, use smaller needles. Repeat until the gauge is correct.

Reading Charts

Unless otherwise indicated, charts are read from the bottom up. On right-side rows, read charts from right to left. On wrong-side rows, read charts from left to right. When knitting in the round, read chart from right to left for all rows.

Wraps Per Inch

If you substitute or spin a yarn for a project, you can compare the weight of the yarn to the project yarn by wraps per inch. The simplest way to do this is to wrap your yarn around a ruler for one inch and count the number of wraps. If you have more wraps per inch, your yarn is too thin; fewer wraps per inch, your yarn is too thick.

Binding Off Shoulder Stitches Together

Place the front and back shoulder stitches onto two separate needles. Hold them in your left hand with the right sides of the knitting facing together. In your right hand, take another needle and insert the right-hand needle into the first stitch on each of the left-hand needles and knit them as one stitch. Knit the next stitch the same way. You now have two stitches on the right-hand needle. Pass the first stitch over the second stitch. Repeat until only one stitch remains on the right-hand needle. Cut the yarn and pull the tail through the last stitch.

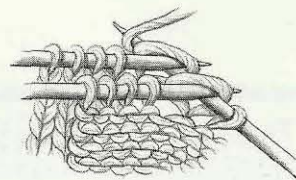

figure 1

Ssk Decrease

Slip two stitches knitwise one at a time (figure 1). Insert the point of the left needle into the front of the two slipped stitches and knit them together through the back loop with the right needle (figure 2).

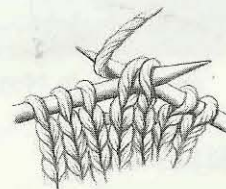

figure 2

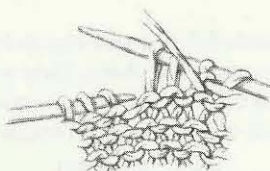

figure 1

Ssp Decrease

Holding the yarn in front, slip two stitches (one at a time) knitwise onto the right needle (figure 1). Slip them back onto left needle and purl the two stitches together through back loops (figure 2).

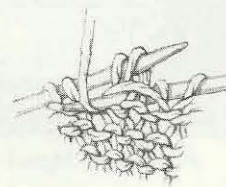
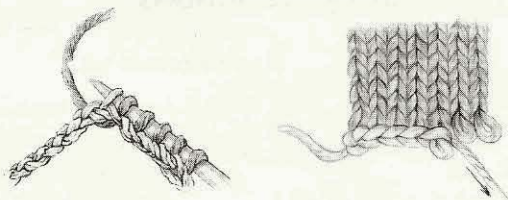

figure 2

Crochet Chain Cast-On



Make a crochet chain 4 stitches longer than the number of stitches you need to cast on. Pick up and knit stitches through back loops of the crochet chain. Pull out the crochet chain to expose live stitches when you're ready to knit in the opposite direction.

Provisional Cast-On

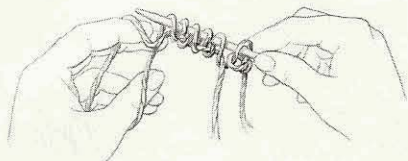

This method is worked with two yarns; the working yarn and a contrasting waste yarn. Place a loose slop knot of working yarn on the needle. Hold the waste yarn next to the slip knot and wind the working yarn under the waste yarn, over the needle, and in front of and then behind the waste yarn for the desired number of stitches. When you're ready to work in the opposite direction, remove the waste yarn and pick up the raw stitches.

Backward Loop Cast-On

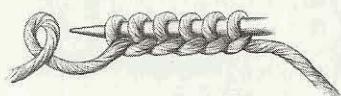

Make a loop in the yarn and place it on the needle backward so that it doesn't unwind. Continue for the required number of stitches, adjusting tension.

Cable Cast-On

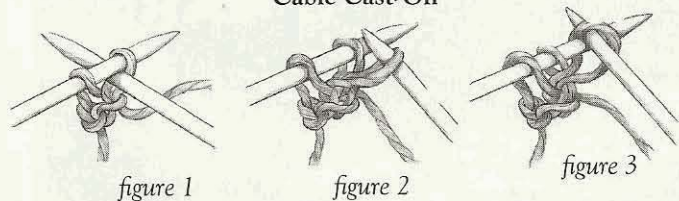

Cast on two stitches using the knitted cast-on method. Insert the right needle between the two stitches on the left needle (figure 1). Wrap the yarn as if to knit. Draw the yarn through to complete the stitch (figure 2), and slip this new stitch to the left needle as shown (figure 3).

I-Cord

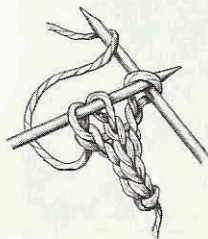

With double-pointed needles, cast on desired number of stitches. *Without turning the needle, slide the stitches to other end of the needle, pull the yarn around the back, and knit the stitches as usual; repeat from * for desired length.

SPARK YOUR STYLE

AVAILABLE JUNE 1999

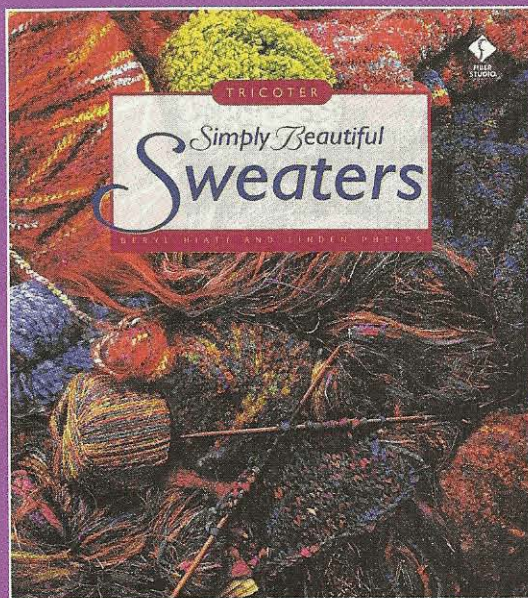

Simply Beautiful Sweaters

BERYL HIATT & LINDEN PHELPS

144 pages, full color, 9" x 10", \$34.95

Knit 20 stylish sweaters that beginners will find easy—and experienced knitters will find irresistible. Using Tricoter's unique chart system for measuring dimensions (instead of counting stitches), you'll learn to create colorful, richly textured pullovers, crop tops, cardigans, and jackets.

1-800-426-3126

Int'l: (425) 483-3313 Fax: (425) 486-7596
Web: www.patchwork.com E-mail: info@martingale-pub.com

Martingale & COMPANY



DEPT. JP

Applied I-Cord

As I-cord is knitted (see page 7), attach it to the garment as follows: With garment RS facing and using a separate ball of yarn and circular needle, pick up the desired number of stitches along the garment edge. Slide these stitches down the needle so that the first picked-up stitch is near the opposite needle point. With double-pointed needle, cast on desired number of I-cord stitches. Knit across the I-cord to the last stitch, then knit the last stitch together with the first picked-up stitch on the garment, and pull the yarn behind the cord (pull the yarn in front of the cord for reverse I-cord). Knit to the last I-cord stitch, then knit the last I-cord stitch together with the next picked-up stitch. Continue in this manner until all picked-up stitches have been used.

Note: When working attached I-cord, do not pick up every stitch. Work the edging for about 2" (5 cm), then lay the piece flat to make sure that the cord lies flat along the edge—if not pull out the necessary stitches and rework, picking up more or fewer stitches along the garment edge, as needed.

CROCHET STITCHES AND ABBREVIATIONS

Chain (ch)

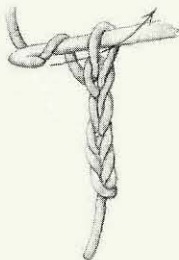

Make a slipknot on the hook. Yarn over the hook and draw it through the loop of the slipknot. Repeat, drawing the yarn through the last loop formed.

Single Crochet (sc)

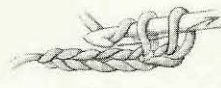

figure 1

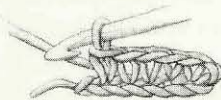

figure 2

Insert the hook into a stitch, yarn over the hook and draw a loop through the stitch, yarn over the hook (figure 1) and draw it through both loops on the hook (figure 2).

Reverse Single Crochet (rev sc)

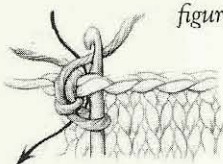

figure 1

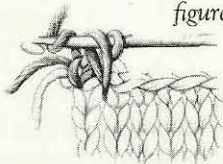

figure 2

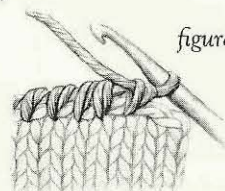

figure 3

Working from left to right, insert the crochet hook into a knit edge stitch, draw up a loop, bring the yarn over the hook, and draw this loop through the first one. *Insert the hook into the next stitch to the right (figure 1), draw up a loop, bring the yarn over the hook again (figure 2), and draw this loop through both loops on the hook; repeat from * until the entire edge has been covered (figure 3). Cut the yarn and secure the last loop by pulling the tail through it.

TIERRA WOOLS

Our ancestors brought sheep to Northern New Mexico 400 years ago and raised flocks organically in high mountain meadows. After handspinning the wool & gathering natural dyestuffs from the wild, they dyed & wove it into richly colored Rio Grande blankets.

Now, the Manzanares family revives that tradition with a flock of more than 1,500 sheep certified organic by the New Mexico Organic Commodity Commission.

Our worker owned company now offers a limited supply of this organic natural dyed knitting yarn, custom spun in plied worsted & sports weights.

Send \$6.00 for sample cards or visit our web yarn store at WWW.OrganicYarn.com or toll free 1-888-709-0979

ORGANIC NATURAL DYED KNITTING YARNS



PHOTO: ROBIN COLLIER

M1 Increase



figure 1

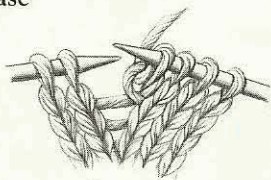
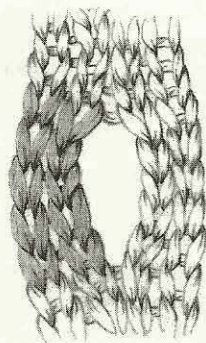

figure 2

With left needle tip, lift the strand between the last knitted stitch and the first stitch on the left needle, from front to back (figure 1). Knit the lifted loop through the back (figure 2).

Vertical Buttonholes



Work a ribbed band to 2 rows before the bottom of the buttonhole position, ending on a right side row. *With wrong side facing, work number of sts to the buttonhole opening. Join new yarn (shown shaded here in cream), work to end of row, turn. Work to the buttonhole opening, cross the 2 yarn ends (as you would in Fair Isle or intarsia to prevent a hole), work to end of row with original working yarn. Work to the buttonhole opening, cross the 2 yarn ends, work to end of row with new yarn, turn. Work to the buttonhole opening, drop new yarn, pick up other yarn (without crossing yarn ends), work to end of row. Cont in rib working the appropriate number of rows for the buttons you've chosen. Work 2 more rows in rib, crossing yarns at buttonhole opening and ending with a right side row. Cut new yarn. With wrong side facing, work to end of row with main yarn and continue to 2 rows before the bottom of next buttonhole, ending on a right side row. Repeat from * for each buttonhole.

Short Row: Wrapping a Stitch

Step 1: Work to turn point, slip next stitch purlwise to right needle. Bring yarn to front.

Step 2: Slip the same stitch back to the left needle (wrapped stitch). Turn work and bring yarn in position for next stitch.

Note: Hide the wraps in a knit stitch when the right side of the piece is worked in a knit stitch. Leave the wrap if the purl stitch shows on the right side. Hide the wrapped stitches as follows: *Knit stitch:* On right side, work to just before the wrapped stitch. Insert the right needle on the front under the wrap from the bottom up and then into the wrapped stitch as usual. Knit them together, making sure that the new stitch comes out under the wrap. *Purl stitch:* On wrong side, work to just before the wrapped stitch. Insert the right needle from the back under the wrap from the bottom up and put it on the left needle. Purl them together.

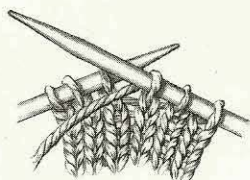

Step 1

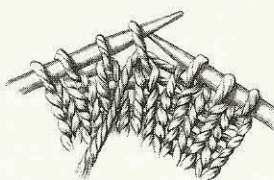

Step 2

INDULGE YOUR CREATIVITY

AVAILABLE JULY 1999

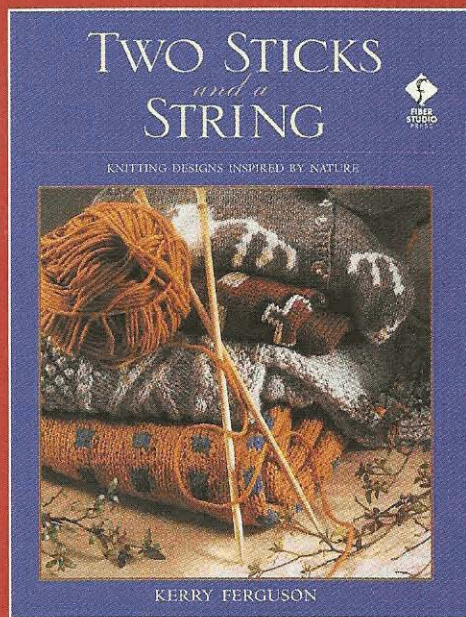

Two Sticks and a String
Knitting Designs Inspired by Nature
KERRY FERGUSON

96 pages, full color, \$29.95

Capture the creative spirit of knitting with a unique blend of traditional design and rustic style. Choose from 15 pullovers, vests, jackets, and cardigans, all enhanced by classic knitting textures and simplified for today's knitter.

1-800-426-3126

Int'l: (425) 483-3313 Fax: (425) 486-7596
Web: www.patchwork.com E-mail: info@martingale-pub.com

Martingale
& COMPANY



DEPT 1P

BEYOND THE BASICS

Dorothy T. Ratigan



Centering Color Patterns

THIS ISSUE OF *Knits* includes many garments inspired by ethnic textiles. Here we'll look at how to go about transferring a found motif into a multi-colored sweater design.

The first question to ask is whether or not you need a balanced pattern. Perhaps not, but consider how most clothing is made. Seams are at the sides of your body or the inside of your arms and legs. Zippers and buttons are usually at the center front or back of a garment, including hats, and you will usually want a pattern to complement this symmetry.

Custom-fitting any motif to a knitted garment takes some planning. But the time you spend number crunching and working out technical bugs is well rewarded when you can knit away, knowing there are no foreseeable problems ahead.

THE SCHEMATIC

The first thing to do is work a schematic for your garment, computing all pertinent numbers for your measurements. (See page 12 for more information.)

INCORPORATING THE PATTERN

Once you've worked your schematic, chart your pattern to establish the number of stitches in each repeat. If you're creating your own motif, graph it out on knitter's graph paper proportional to your stitch and row gauge. (You will first have done a stockinette-stitch swatch in your chosen yarn to determine the gauge.) Our example has a 14-stitch, 14-row repeat. Because the first stitch and first row of the repeat are also the last stitch and last row of the pattern, you need to add one stitch and one row to the final repeat for balance. These "balance" stitches are shown in the shaded areas of the chart.

Most designs have an "up" point, marked A on the chart, and a "down" point, marked B. One of these points will be the center front of your garment. The most important area to consider when choosing the center is the neck edge—

because the pattern is more visually prominent here than in the body of the sweater.

The next step is to make a pattern swatch with your chosen yarn. If your pattern gauge is different from your stockinette-stitch gauge, you'll need to recalculate the number of stitches in your garment to get the desired finished size. Wash and dry the pattern swatch as you will the finished garment. Then remeasure for accuracy. For this exercise, let's say our gauge is 6 stitches and 8 rows per square inch.

LET'S BEGIN

The desired finished chest/bust circumference is 40". Divide the 40" by two to get 20" for the front and 20" for the back. Multiply this width by stitch gauge to get the number of stitches needed: 20" × 6 stitches/inch = 120 stitches. Add two edge stitches for the seams, but do not include them in the stitch count for patterning.

To determine how many pattern repeats you'll have, divide the total number of stitches by the number of stitches in one repeat: 120 stitches ÷ 14 stitches = 8½ pattern repeats plus one balance stitch. While this computation does, indeed, equal 120 stitches, it involves a partial repeat. You'll need to choose one of the following options.

1. By placing a "down" point (B) at the center front, you'll have 4¼ motifs on each side of the center. When you join the seams, you'll have two ¼-motifs abutting at the sides. You could go with this and hope no one notices.
2. Work the pattern in the round on 238 stitches, which gives you 17 pattern repeats. Because there is an odd number of repeats, the center front or back will have an "up" point and its opposite will have a "down" point. You can also work this flat, putting an "up" at center front or back and a "down" as its opposite. However, either solution will mean that the patterns don't match at the shoulders. You can, however, compensate for this too (see 1-4 on page 11).
3. Adjust the number of stitches so that you work only with whole repeats. By recalculating for a 42" finished garment, your numbers will look like this: 21" × 6 stitches per inch = 126 stitches. Divide 126 stitches by 14 stitches per pattern repeat and you get 9 pattern repeats. Add 1 stitch for balance and you have a perfect fit of stitches and

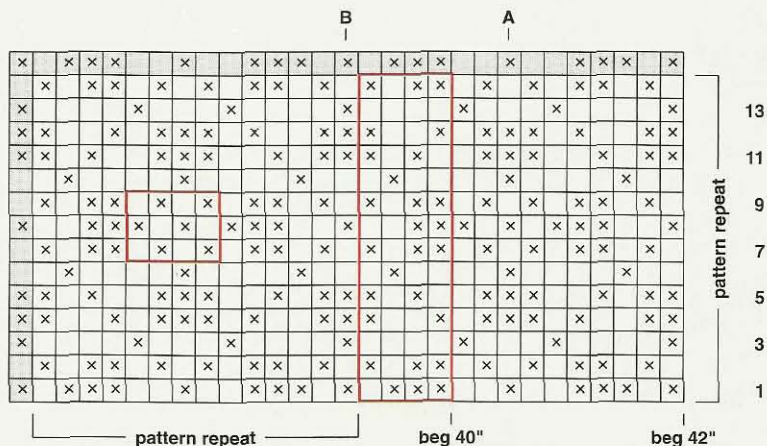

pattern repeat. If 42" is too big, you can change your needle size for a tighter gauge.

Depending how you seam the garment, you can omit the balance stitch and join the two pieces to look like a continuous piece. Because you'll be working here with an even number of stitches, the pattern at the center front and back will be off by 1 stitch, but this will hardly be noticeable.

If you are into "absolute" balance, you can bind off an even number of stitches at one underarm and an odd number of stitches at the other. For example, bind off 4 stitches at the underarm, work to end of row in pattern, turn. Bind off 3 stitches, work to end of row in pattern. Do the same for the sleeve, only work the odd number of stitches first, then the even. The sleeve underarms will match the body, and the top center sleeve stitch will match the shoulder seam.

If you're planning an allover pattern, it's important that the body and sleeves end on the same pattern row. To ensure this, work the sleeves first to desired length. To determine which pattern row to begin the body with, lay the sleeve flat and measure down from the underarm to desired *body* length. Allow for depth of rib, and begin with Row 1 or 8 of pattern.

The only thing left to be factored in is the shoulder seam. If you're working with an even number of repeats and end the back shoulder edge on Row 14 or 7, and the front shoulder edge on Row 1 or 8, you'll have a perfect pattern match when knitting, sewing, or weaving the shoulders together.

If you're working with an odd number of pattern repeats (like the 17 above), your shoulder stitches will not match. If it doesn't matter, carry on. If it does matter, you have a few options.

1. Work a small 2- or 3-row pattern picked out of the main pattern (outlined as a small red box in the chart), finishing both front and back shoulders with these rows.
2. Work a few rows of garter stitch at shoulder edges before binding off.
3. Shape shoulders using short rows of the main color.
4. With wrong sides together, bind off with a decorative braid or cord such as the one used in Meg Swansen's "Bavarian Twisted-Stitch Cardigan" on page 45.
5. With stitches on two needles and wrong sides together, bind off in single crochet, alternating stitches in one, two, or more colors.

If there are multiple patterns in the garment, they should all share a common center point and then ease out to the seam. When working Fair Isle, you generally have large patterns separated by small peeries. Many times, the multiples of the large pattern—on which the garment size is based—do not match the repeat of the smaller peerie. Do your math and then either increase or decrease stitches to the next nearest peerie pattern repeat. (This technique is used for the "Maghrib Vests" shown on page 23.) Because you work these few increases/decreases over some 200 to 300 stitches, they are imperceptible. After working the peerie, reverse the procedure.

Whether your sweater is traditional or contemporary, pictorial or geometric, these techniques will help you design it so it works. ∞

Dorothy T. Ratigan is technical editor for *Interweave Knits* and *PIECEWORK* magazines. She teaches knitting and lives in Cape Elizabeth, Maine.

DEVELOP YOUR DECOR

AVAILABLE SEPTEMBER 1999

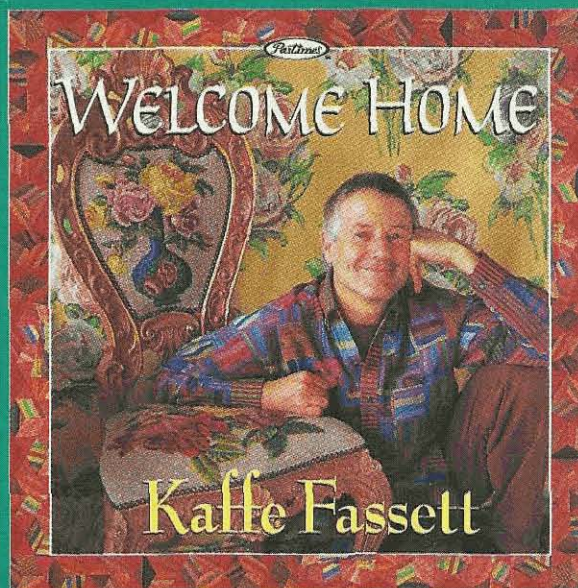

Welcome Home: Kaffe Fassett

128 pages, full color, hardcover, 10" x 10", \$29.95

Tour the eclectic London home of world-renowned knitter, quilter, needle artist, and designer Kaffe Fassett, then re-create his distinctive look in your home with 14 do-it-yourself projects, including hooked rugs, quilts, pillows, and mosaics.

1-800-426-3126

Int'l: (425) 483-3313 Fax: (425) 486-7596
Web: www.patchwork.com E-mail: info@martingale-pub.com

Martingale
& COMPANY



DEPT. IP



Subscribe Today!

Interweave

Knits

- ✿ Estonian knitting techniques
- ✿ Patterns inspired by world textiles
- ✿ Behind-the-scenes at Icelandic Design

Great features like these appear in *Interweave Knits* four times a year.

Plus, twice a year, subscribers receive a special newsletter with lots of extra projects and knitting news.

To make sure you receive *Interweave Knits*, and your free subscriber-only newsletters, subscribe or renew today!

\$24 (1 yr., U.S.)
800-645-3675

Dept. A-KB

INTERWEAVE PRESS
201 E. Fourth St.
Loveland, CO 80537-5655
www.interweave.com



MAKING A SCHEMATIC

Below are the measurements you'll need to work out a schematic. You can save yourself a lot of time and guesswork by taking the measurements off a well-fitting sweater. Otherwise, ask a (good) friend to take your measurements, and then add the desired amount of ease. Knit a generous test piece to get an accurate measurement of knitted stitches per inch and rows per inch. Multiply the measurements on your schematic by your gauge to get the number of stitches or rows necessary for the desired measurement.

- A Shoulder width: armhole seam to armhole seam
- B Front or back width: (bust/chest or hip circumference, whichever is larger) ÷ 2
- C Underarm width: (B - A) ÷ 2
- D Neck width: (1/3 of A)
- E Shoulder width: (1/3 of A)
- F Armhole depth: top of shoulder to 2" (5 cm) below armpit
- G Lower body length: underarm (not armpit) to desired total length, including ribbing
- H Total body length: F + G
- I Front neck depth: 2" to 3" (5 to 7.5 cm)
- J Sleeve length: underarm to top of cuff
- K Sleeve cuff length: typically 2" to 3" (5 to 7.5 cm)
- L Sleeve width at shoulder: 2 × F
- M Sleeve width at wrist: wrist circumference plus 1" to 2" (2.5 to 5 cm)

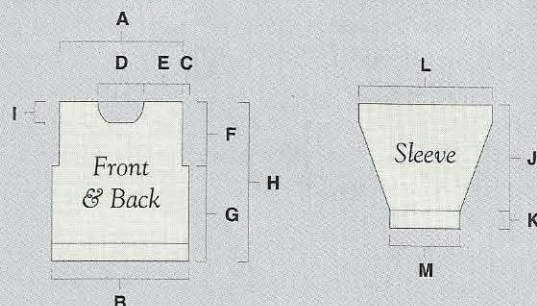

OOPS!

Visit our website at www.interweave.com for corrections to all issues of *Interweave Knits*.

Spring 1999

Product News (page 78)

The correct phone number for The Fiber Gypsy is (407) 898-9439.

Summer 1999

A Place for Everything: Needle Storage Solutions (page 52)
Ellen's Originals can be purchased from Ernestine's Knitting Studio, PO Box 694, Silver Spring, MD 20918. (301) 754-3865; www.knit-crochet.com.

Little Skipper

 (page 20)

On the collar, inc 3 (2, 3) sts on last row of ribbing—52 (59, 66) sts. Purl 1 row. Knit 4 rows. Change to larger needle. Keeping the first 4 and last 4 sts in established rib, work Rows 1–5 of circle-lace on center 44 (51, 58) sts. Knit 4 rows. Purl 1 row. Knit 3 rows. Purl 1 row, dec 3 (4, 5) sts evenly spaced—49 (55, 61) sts. Continue as written.

Product News

 (page 72)

The correct website for Pangaia Designs is: www.swakknit.com.

Adding Variety to Color

Your full spectrum hand-dyed yarn source for multi-color and coordinating nearly-solid yarns in a range of fibers and weights. **EVEN** our buttons match!



Sampler Bouquet Bubble Vest
ask for our yarns at your favorite shop or mail order source - wholesale inquiries welcome

Lorna's Laces Yarns

(530) 626-4514

miser@inforum.net

P.O. Box 795

Somerset, CA 95684

TIUR...

A luxurious blend of mohair and wool in 20 irresistible colors.



Book 107



Dale of Norway

The perfect blend of inspiration and quality in natural fibers. Introducing five exciting books for kids and adults featuring Heilo, Falk, Tiur, Kolibri, Free Style, Daletta and Baby Wool.

Call for your nearest store and our free brochure.

1-800-441-DALE

N16 W23390 Stoneridge Dr., Ste. A
Waukesha, WI 53188

THE Web-sters

JO SHARP

KNITTING
BAZAAR

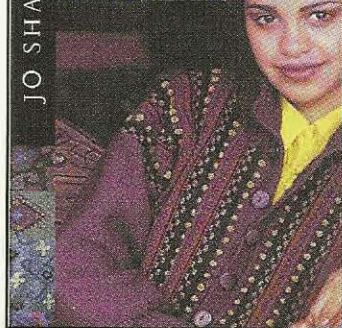

NEW BOOK

Knitting Bazaar

Hand Knitting Collection
by Jo Sharp

\$28 plus S&H

Free COLOR CATALOG

1-800-482-9801

websters@mind.net

THE WEB-STERS

11 N. MAIN STREET
ASHLAND, OR 97520

HANDSPINNERS WEAVERS & KNITTERS

Alice Starmore
Rowan
Fiesta Yarns
Philosopher's Wool
Dale of Norway
Tahki
Brown Sheep
Vittadini
Manos
Lorna's Laces
Mountain Colors
K1 C2
Jo Sharp
Green Mountain
Berroco
Classic Elite
Prism
Noro
Crystal Palace
Froehlich
Great Adirondack

ICELANDIC DESIGN

GROWING A BUSINESS

Marilyn Murphy



Andy and Gerdur started Icelandic Design in the early 1980s.

WANDERING around downtown Longmont, Colorado, about a year ago, I was stopped by a display of richly colored and attractively designed sweaters in the window of a renovated storefront. Peering inside, I saw that more sweaters lined the walls. When I saw the lettering on the window, I realized that “Icelandic Design” was the very company that had recently sent me an invitation to visit. I immediately made an interview appointment for our photographer, Joe Coca, and myself.

The wife-and-husband owners of Icelandic Design, Gerdur Kristjansdottir and Andy Fitts, greeted us. I was surprised to learn that they had been in business since the early 1980s. Given that they’re located only twenty minutes from our offices in Loveland, Colorado, I wondered



Lead designer Deborah Doyle discusses a new line with one of the sales representatives.

why I hadn't noticed them before. As it turns out, they'd only recently moved from Boulder into this large 1907 building. The move has allowed them to bring all aspects of their business under one roof and provides for expansion.

AN UNPLANNED BEGINNING

Little did Gerdur know, when her mother sent her a few handknitted Icelandic sweaters in the early 1980s that it would spark the beginning of a business. Impressed by the craftsmanship of the sweaters, Gerdur began designing sweaters herself and sending the sketches back to Iceland. Her mother and other family members knitted the designs and sent the finished sweaters back and Gerdur and Andy sold them to friends in the Boulder area.

Gerdur's early designs were traditional, using primarily white and natural colors. For the first six years, she and Andy sold Icelandic designs exclusively, and soon became the largest producer of handknitted sweaters in Iceland. When Gerdur began translating traditional designs to accommodate American tastes, her Icelandic knitters resisted—they had trouble breaking out of their traditional mindset and working style. Once she introduced mohair into the collection, Gerdur moved part of the production out of Iceland to Denmark. But remaining true to her heritage, she kept the name "Icelandic Design."

The sweater-design business didn't exactly tie in to either Gerdur's or Andy's backgrounds. Although Gerdur was born in Reykjavik, Iceland, and knitting is part of her heritage, she has been living in the United States since she was twenty-two. She earned a masters degree in psychological counseling and practiced in the field for fifteen years. Andy holds a degree in comparative religions and his only business venture before Icelandic Design was importing clothes from Bali. Gerdur designs and oversees the creative end of the business while Andy takes care of the business side, working with sales and marketing, finances, and future planning.

SPANNING THE GLOBE

The move into Shetland-weight yarns took Gerdur and Andy to China, where trained machine knitters are accustomed



The Landscape Collection employs a palette of eighty colors.

to working with fine-gauge yarns; they also excel at complicated, multicolored designs and have excellent finishing techniques. Icelandic Design works with two manufacturers experienced in knitting and finishing techniques for high quality garments—one is strong in handknitting, the other machine knitting. These arrangements enabled Icelandic Design to introduce the Landscape Collection, comprised of seven sweaters made with Shetland-weight wool. Each design incorporates fourteen to seventeen colors—in all, the collection employs a palette of eighty colors.

It is extremely important to both Gerdur and Andy that they work within cooperative structures. Gerdur is emphatic about working with women and creating healthy economic positions that allow them to be at home with their families. About seven years ago, the firm started working with women in the Kathmandu Valley of Nepal where the knitting industry originated as part of the carpet industry. Relying on this established artistic tradition, the valley provides Icelandic Design with no less than 300 female knitters, all coordinated through a local cooperative. The artisans knit in their homes, exercising and taking pride in their craftsmanship, while the cooperative provides technical training and keeps track of shipments and who's working on what garments.

Because the Nepalese are very willing to try new things, many of the designs that Gerdur sends them are free-form. Most patterns are intarsia, knitted from a blend of Tibetan and Australian wool that is kettle-dyed and has a handspun look. The collection knitted in Nepal is named Newari after the Newar, the original tribal people in the Kathmandu Valley. Each sweater has subtle variations, and the Aztec Daisy Cardigan on page 17 comes from this collection. Newari also has a full line of knitted accessories made in small villages by disabled people who would not otherwise have employment.

Twice a year, Gerdur and Andy visit their Chinese manufacturers and the Nepalese coop. This is a time for training in any new techniques introduced to the collection. It's also a way of staying in touch with the people who produce the high quality sweaters that Icelandic Design is known for.

DESIGNING A LINE

Icelandic Design emphasizes detail and patternwork. All garments are made with beautiful fibers, and rich surface texture is created by pattern stitch, or by embroidery and knitted borders. The floral tapestry line—a triumph of feminine elegance—is particularly well-known. Gerdur designs the garments around the yarn—she says it's like becoming friends with the fiber. She never puts anything into the collection unless it's beautiful and evokes the passion of the person who wants to wear an Icelandic Design, someone who has a deep appreciation of wearable art.

In addition to the basic Shetland and Shetland-weight wool, the collection uses other natural fibers including blends of silk, lamb's wool, angora, mohair, cashmere, and rayon chenille. Recent additions include linen, cotton, and hemp.

The primary selling season is fall/winter, and only a few sweaters span spring/summer. Consisting of about sixty-five sweaters with an average of two colorways per design, the collection also includes an accessory line of gloves, hats, mittens, and bags. Gerdur starts designing for the next year's collection in February, and spends significant time reviewing the previous season for what worked and what didn't. Four-fifths of every year's line is new



Design inspiration for Icelandic Design lines comes from magazines, books, and textiles.

and the other fifth comprises the most popular items from previous years. A few designs have been carried through for six years with slight modifications.

Gerdur pulls ideas from all sorts of sources—magazines, museum collections, and textiles—and plans them in groups such as Nordic, tapestry, or Celtic. Her initial sketches are rendered in black and white and move into watercolor at a later stage. She makes machine-knitted swatches, checks the gauge and stitch pattern, then does the final designs on the computer. She swatches the final designs again and develops the color palettes.

Outside advisers usually help make a decision on the final two colorways for each design. Elements from various designs are combined, and the design lines go overseas to be sampled. When the samples come back, the sales department helps consolidate them. Then the refined designs are sent back overseas, samples are knitted, photography is done, and a catalog is produced. The collection is then introduced to the sales reps and marketing begins. Ten

groups of reps cover the United States and Canada, and Icelandic Design attends three to four national shows a year focused on the outdoor, ski, and boutique market.

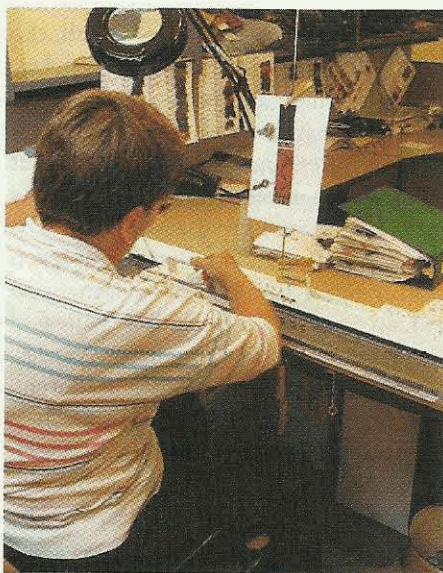

Swatches are machine-knitted, checked for gauge and color, and knitted again before a design is finalized.

FUTURE PLANS

Icelandic Design is just that—a “design” company—so it’s not limited to producing handknitted garments. The door is open to future ventures like designing and printing cloth or upholstery fabric. Right now the firm designs private-label knitted lines for a few American companies.

Currently focused on helping retail clients increase sales through merchandising techniques, Icelandic Design has been experimenting with wooden displays that maximize space and create a unified look. Eight hundred stores sell the collection in the United States, one hundred sixty in Canada, and in Iceland a chain store sells the sweaters. For right now, Andy observes, “We’re just tending to our knitting and looking to a healthy future.”

Marilyn Murphy was inspired to know that businesses such as Icelandic Design are working with issues of cross-cultural sustainability and making a difference in people’s lives. For more information, visit their website at www.icelandicdesign.com.

AZTEC DAISY
CARDIGAN





AZTEC DAISY CARDIGAN

ICELANDIC DESIGN

Color and texture

Front pockets

FINISHED SIZE 42 (45, 48)" (106.5 [114.5, 122] cm) chest/bust circumference. Sweater shown measures 42" (106.5 cm).

YARN Brown Sheep Lamb's Pride Bulky (85% wool, 15% mohair; 125 yd [114 m]/100 g): #M56 clematis (MC), 7 (8, 9) skeins; #M150 bulldog blue, #M25 garnet, #M14 sunburst gold, #M15 gold glow, #M18 khaki, #M135 April green, #M180 ruby red, #M97 rust, 1 skein each. Brown Sheep Lamb's Pride Worsted (85% wool, 15% mohair, 190 yd [174 m]/100 g): #M25 garnet, 2 skeins.

NEEDLES Size 9 (5.5 mm). Adjust needle size if necessary to obtain the correct gauge.

NOTIONS Tapestry needle, size G/6 and H/8 (4.25- and 4.75-mm) crochet hook; nine $\frac{7}{8}$ " (2.2-cm) buttons.

GAUGE 17 sts and 19 rows = 4" (10 cm) in St st and textured patt.



Brown Sheep Lamb's Pride Bulky singles: 8 wraps per inch

A WASH WITH COLOR and texture, this bulky-weight cardigan can double as a jacket. The edges are trimmed with a row of single crochet followed by a row of reverse single crochet, all worked with two or three strands of worsted-weight yarn.

Pattern Stitch:

Row 1 and all odd-numbered rows: (RS) Knit.

Rows 2 and 6: Purl.

Row 4: P2 (3, 2), *k1, p3; rep from *, k1, p2 (3, 2).

Row 8: P4 (5, 4), *k1, p3; rep from *, k1, p4 (5, 4).

Rep Rows 1–8 for patt.

•**Back:** With bulldog blue, CO 89 (95, 101) sts. Work 22 (24, 26) rows St st. Beg with Row 1, work Lower Back chart as instructed. With MC, work patt st until piece measures 16 (16½, 17)" (40.5 [42, 43] cm) from beg, ending with a WS row. **Shape armholes:** (RS) Cont in patt, BO 2 (3, 4) sts at beg of next 2 rows—85 (89, 93) sts rem. On next row, beg Upper Back chart as foll: Work 11 (13, 15) sts in patt, work Row 1 of chart over next 63 sts, work to end in patt. Work to end of chart, cont patt st as established in MC areas, then cont in patt st until armhole measures 9¼ (9½, 10)" (23.5 [24, 25.5] cm). **Shape neck and shoulders:** Work 31 (32, 33) sts in patt, join new yarn and BO center 23 (25, 27) sts, work to end of row. Working both sides separately, BO 9 sts at each arm edge 3 (2, 1) time(s), then 10 sts 0 (1, 2) times, and *at the same time*, BO 2 sts at neck edge 2 times.

•**Pocket Liner:** (make 2) With bulldog blue, CO 21 (23, 25) sts. Work 30 (32, 34) rows St st. Place sts on holder.

•**Left Front:** With bulldog blue, CO 44

(47, 50) sts. Work 4 (6, 8) rows St st. Beg with Row 1, work Left Front chart as instructed, inserting pocket liner and working patt st as indicated until piece measures same as back to armhole, ending with a WS row. **Shape armhole:** Cont in patt, BO 2 (3, 4) sts at arm edge—42 (44, 46) sts rem. Cont in patt until armhole measures 3" (7.5 cm). **Shape neck:** Dec 1 st at neck edge 15 (16, 17) times as charted—27 (28, 29) sts rem. Shape shoulder as for back. Shape shoulder as for back. Mark placement of 7 buttons, one ½" (1.3 cm) from lower edge, one ½" (1.3 cm) from neck edge, and the other 5 evenly spaced in between.

•**Right Front:** Work as for left front, reversing shaping and chart and working vertical buttonholes (see Glossary, page 9) for 2 rows 1 st in from edge, opposite markers.

•**Sleeves:** With bulldog blue, CO 45 (47, 49) sts. Work 3 rows St st. Beg with Row 1 as indicated for your size, work to end of Sleeve chart, then change to patt st. And *at the same time*, inc 1 st each end of needle every 6 rows 17 (17, 19) times—79 (81, 87) sts. Work even until sleeve measures 19 (19, 19½)" (48.5 [48.5, 49.5] cm), or desired length from beg. BO all sts.

•**Finishing:** With yarn threaded on a tapestry needle, sew shoulder seams. Sew sleeves into armholes. Sew side and sleeve seams, matching color changes. Sew pocket linings in place. **Braid:** With smaller crochet hook, 2 strands of worsted-weight garnet, and beg at right back neck, work 1 row sc (see Glossary, page 8 for crochet instructions) around neck, front, and lower edges. Join third strand of garnet and larger crochet hook and work 1 row rev sc over sc. Work same braid around sleeve cuffs and pocket tops. Weave in loose ends. Block. Sew on buttons. ∞

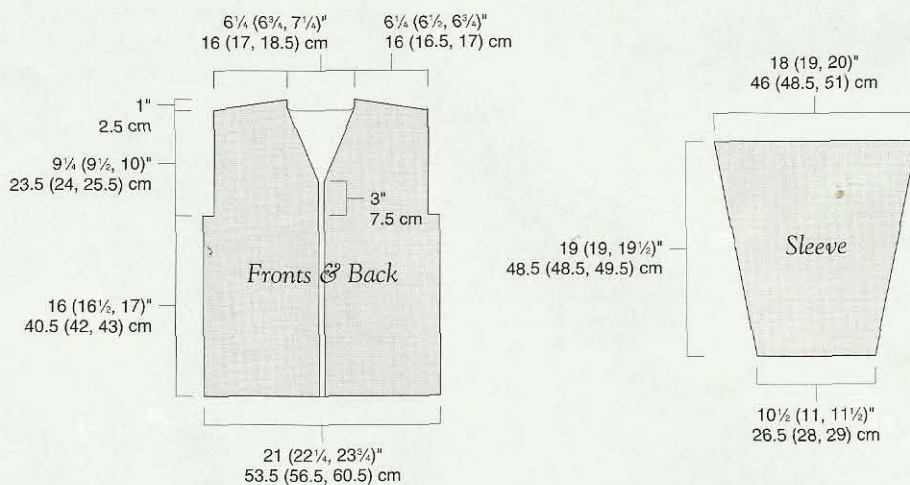

Left Front

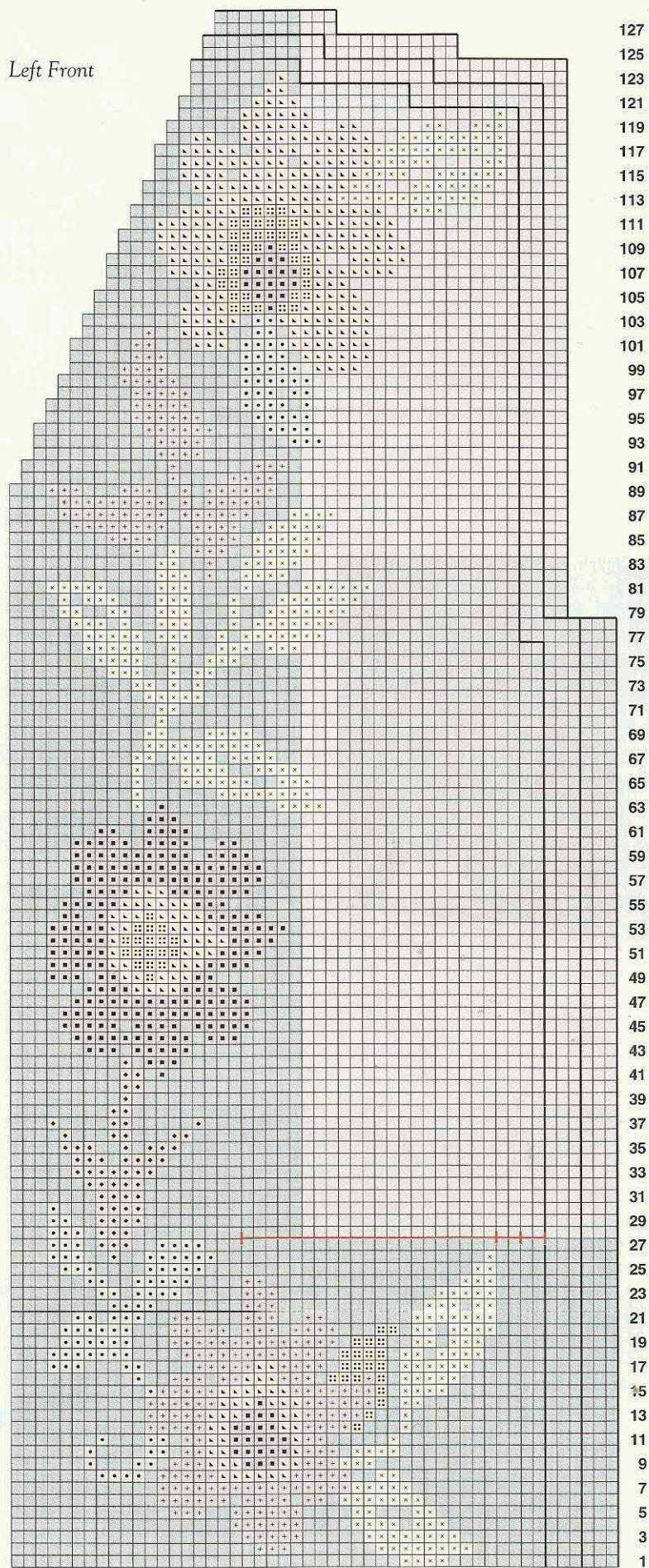

- clematis
- bulldog blue
- garnet
- ▲ sunburst gold
- × April green
- ⋈ gold glow
- khaki
- + ruby red
- ◆ rust
- insert pocket

With bulldog blue, CO 44 (47, 50) sts and work 4 (6, 8) rows St st. Beg as indicated for chosen size. On Row 27, work 4 (5, 6) sts, BO next 21 (23, 25) sts for pocket, work across 21 (23, 25) pocket liner sts on holder, cont in patt st and intarsia to underarm. At armhole edge, BO 2 (3, 4) sts. Work even through Row 89. Beg neck shaping: Dec 1 st at neck edge 15 (16, 17) times according to chart. Shape shoulders: At armhole edge, BO 9 sts 3 (2, 1) time(s), then 10 sts 0 (1, 2) time(s).

S M L

Upper Back

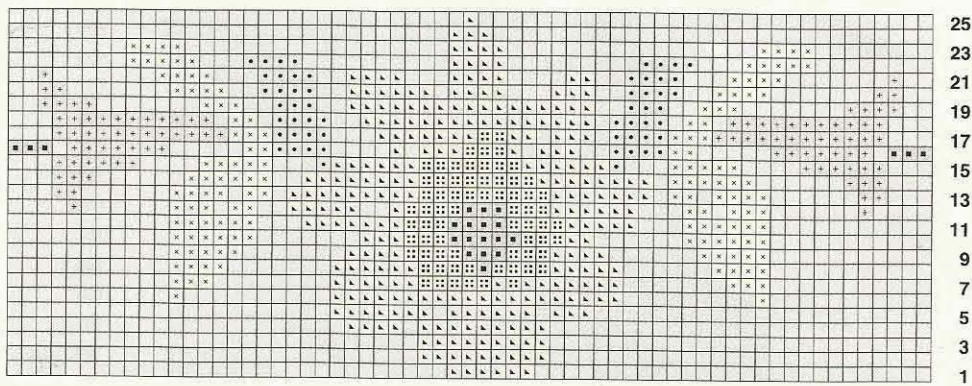

Work 11 (13, 15) sts in patt, work chart, work 11 (13, 15) sts in patt.



Lower Back

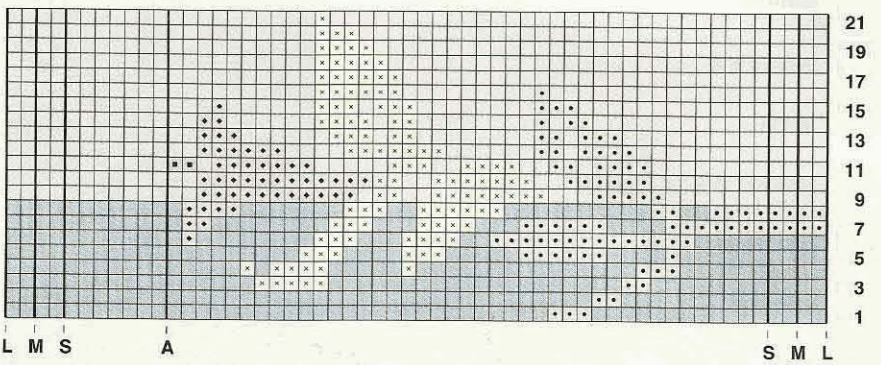

Begin as indicated for chosen size. Work to left marker for chosen size; then work from A back to first marker.

Sleeve

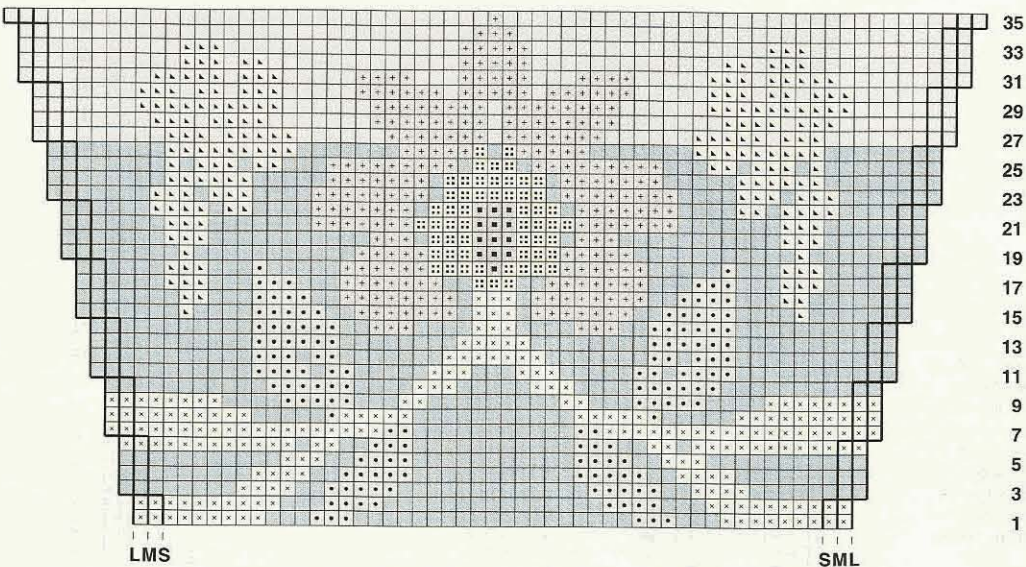

WEEKENDER CARDIGAN

Designed by JACQUELINE OLSEN

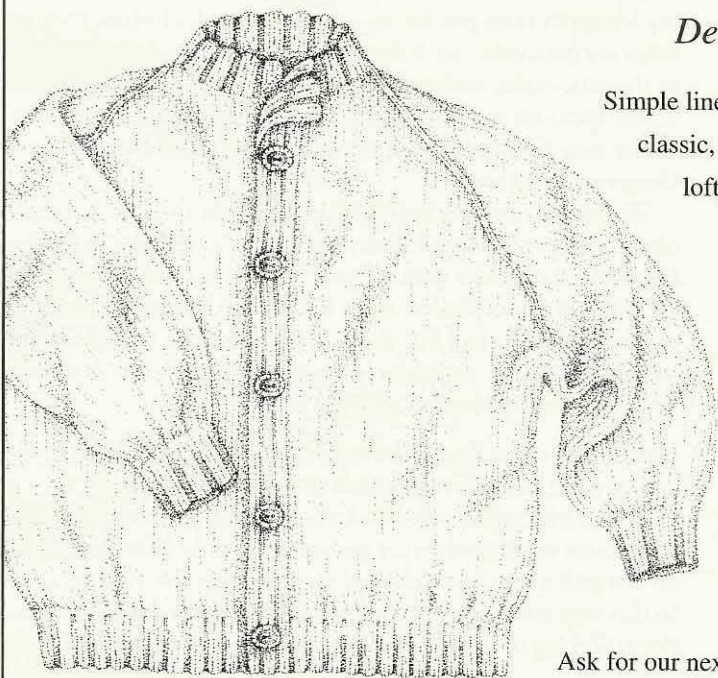

Pattern not sold separately.

Simple lines, timeless ease. Our exclusive knitter's kit for a perfectly classic, endlessly comfortable raglan cardigan. Quick to knit with lofty, undyed New Zealand wool in natural, heathery shades—oatmeal, warm silvery tan or rich deep brown. Includes handcrafted, beautifully polished buttons of shed antler.

Unisex sizes S/M(48" finished chest) or M/L(58" finished chest). *Kit, \$129*

Add \$9 shipping/handling for US destinations.

New York residents add sales tax

Questions?

914.336.5322

Orders only, toll-free

1.888.SEW.KNIT

Ask for our next edition of the Knitter's Folio



2010 ULSTER AVENUE • POST OFFICE BOX 758 • LAKE KATRINE, NEW YORK 12449

www.amazingthreads.com

Introducing

Jasmine Yarns

Luxurious 100% virgin wool
and rayon chenille twist
from Harrisville Designs

Available in fine and heavy weights
10 color combinations in a fine weight and 5 in heavy

Jasmine Yarns sample card: \$2.50
1-800-338-9415



HARRISVILLE DESIGNS

Center Village, Box 806

Harrisville, New Hampshire 03450



MAGHRIB VESTS

SANDY CUSHMAN

Unisex styling

Knitted in the round

FINISHED SIZE 36¼ (40, 43½, 47¼, 51, 54½)" (92 [101.5, 110.5, 120, 129.5, 138.5] cm) bust/chest circumference, zipped. Green vest shown measures 43½" (110.5 cm); purple vest shown measures 47¼" (120 cm).

YARN Berroco Bluefaced Leicester (100% wool; 103 yd [95 m]/50 g): **Green colorway:** #7007 sage and #7012 boysenberry, 3 (3, 3, 3, 4, 4) balls each; #7018 dahlia and #7014 olive, 1 (1, 1, 1, 2, 2) ball(s) each; #7015 teal, #7009 deerskin, and #7013 black, 1 ball each. **Purple colorway:** #7013 black, 4 (4, 4, 4, 5, 5) balls; #7018 dahlia, 3 (3, 3, 3, 4, 4) balls; #7006 British blue, #7002 burgundy, #7015 teal, #7004 evergreen, and #7014 olive, 1 ball each.

NEEDLES Body—Size 7 (4.5 mm): 29" (80-cm) circular (cir); Edging—Size 6 (5 mm) 29" (80-cm) cir and double-pointed (dnp). Adjust needle sizes if necessary to obtain the correct gauge.

NOTIONS Size F/5 (3.75-mm) crochet hook; markers (m); stitch holders; waste yarn; 16" (40.5-cm) separating zipper; small sewing needle; blunt tapestry needle.

GAUGE 22 sts and 23 rows = 4" (10 cm) in color patt; 23 sts and 26 rows = 4" (10 cm) in St st.

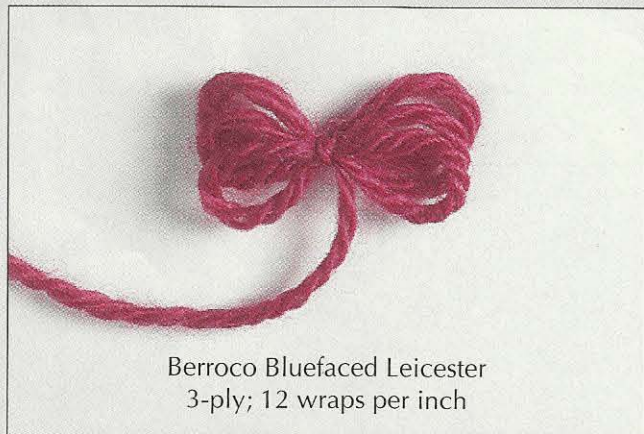

Berroco Bluefaced Leicester
3-ply; 12 wraps per inch

LIKE THE KIND of outerwear that you find in hardware stores. Its design clearly reflects its function: work. Armholes are cut generously to allow freedom of movement, necks fit snugly to keep out the cold, zippers replace fussy button closures. While my Maghrib vests pay homage to those work clothes, they indulge my fascination with the richness of color and pattern found in the arts, crafts, and architecture of the Arab-Islamic world. I find inspiration in the motifs unique to Moroccan textiles, and in the way that they have been interpreted by painters from Gauguin to Matisse.

These vests are worked "in-the-round" in the Fair Isle technique, using only two colors at a time. The "body tube" is worked from hip to shoulder with a 5-stitch steek at the front opening and each of the armholes. After I complete the body, I machine stitch the steeks and cut them open. I-cord is picked up and worked around the perimeter of the vest and armholes. A serviceable zipper completes the vest.

Notes: The round begins at the front steek. Knit the steek stitches alternating colors every stitch and every round.

When picking up stitches for I-cord edging, remember that stitches on vertical edges are picked up directly onto the needle; do not pull a separate strand of yarn through the existing ones. In this way, you can work the I-cord on the front opening in sections, picking up and working 10 to 15 stitches at a time.

•**Body:** Using the crochet chain method (see Glossary, page 7), CO 204 (228, 246, 264, 288, 306) sts, using larger needle and olive (for the green colorway) or black (for the purple colorway). Place m and join, being careful not to twist sts. Knit 5 (steek) sts and place another m. Note: From this point forward, steek sts will not be included in st counts. Purl 1 rnd. Knit 1 rnd. Beg chart (see page 25) on Rnd 1, following written directions below for all dec/inc rnds marked on chart:

Rnd 11: Inc 1 (dec 3, dec 1, inc 1, dec 3, dec 1) st evenly spaced—200 (220, 240, 260, 280, 300) sts.

Rnd 15: Dec 3 (inc 5, dec 1, inc 7, inc 1, dec 5) sts evenly spaced—197 (225, 239, 267, 281, 295) sts.

Rnd 24: Inc 3 (dec 5, inc 1, dec 7, dec 1, inc 5) sts evenly spaced—200 (220, 240, 260, 280, 300) sts.

Rnd 28: Inc 1 (dec 3, inc 1, dec 3, inc 1, dec 3) sts evenly spaced—201 (217, 241, 257, 281, 297) sts.

Rnd 36: Inc 0 (4, 0, 4, 0, 4) sts evenly spaced—201 (221, 241, 261, 281, 301) sts.

Work 51 rnds of chart, then rep Rnds 36–51 without any further dec or inc until piece measures 14 (13¼, 12¾, 12¼, 11¾, 11¼)" (35.5 [33.5, 32, 31, 30, 28.5] cm), or desired length from beg.

Shape armholes: Cont in patt, work 40 (45, 50, 55, 60, 65) right front sts, place next 20 sts on holder for right armhole, pm, CO 5 steek sts, pm, work 81 (91, 101, 111, 121, 131) back sts, place next 20 sts on holder for left armhole, pm, CO 5 steek sts, pm, work 40 (45, 50, 55, 60, 65) left front sts. Dec 1 st each side of each armhole steek every row 4 (5, 5, 7, 9, 9) times—36 (40, 45, 48, 51, 56) sts rem on each front; 73 (81, 91, 97, 103, 113) sts rem on back. Cont even until piece measures 17½" (44.5 cm) from beg (for all sizes). **Shape neck:** Dec 1 st each side of front steek every row 6 (8, 10, 10, 14, 16) times, then every other row 11 (11, 10, 11, 9, 8) times—19 (21, 25, 27, 28, 32) sts rem each front, ending on Row 36 or 44. Place sts on holders.



•**Finishing: Cut steeks:** Sew a vertical row of machine stitches (small zigzag) on each side of the center steak st. Cut steak open through the middle st from top to bottom. Join shoulders by BO shoulder sts tog (see Glossary, page 6). **Lower and front edging:** Unravel crocheted chain at lower CO edge. Slide sts onto smaller cir needle. With WS facing, dpn, and olive (for green colorway) or black (for purple colorway), work 3-st applied I-cord (see Glossary, page 8) from right to left, dec about 10% of total body sts (for example, dec 20 sts for smallest size) evenly spaced to end of lower edge. Work unattached I-cord for 3 rnds for corner. *Place 3 I-cord sts onto dpn (this is now the right needle) and drop yarn. With WS facing and steak folded towards you, pick

up the vertical edge sts by inserting tip of cir needle into center of st from front to back. Working in sections of 10 to 15 sts, pick up 5 of every 6 rows. Work applied I-cord over these sts* up front edge to shoulder seam. Slide back neck sts onto cir needle. Work applied I-cord to shoulder seam, dec 4 sts evenly (for all sizes). Rep from * to * down other front. Work 3 rnds unattached I-cord. Sew ends of I-cord tog. **Armbands:** Beg at back of underarm, work I-cord as before, dec 3 sts (for all sizes) at underarm. With sewing needle and single ply of yarn, use a cross-stitch to secure edges of steeks. Tack down bottom edges of steeks. Weave in loose ends. Block. Sew in zipper (see page 66), stitching in the "ditch" between body and I-cord. *To shorten zipper:*

Trim zipper at top to fit front opening. Apply FrayCheck or overcast top to prevent raveling. Bind zipper teeth 1/4" (6 mm) from top to make a "stop". ∞

Sandy Cushman graduated from the Rhode Island School of Design, where she studied painting and textiles. She recently moved to Dolores, Colorado, with her husband and various pets. Though she's knitted many years, it wasn't until she settled in the West that she began designing. Clearly, living at 7,000 feet above sea level has had a positive effect.

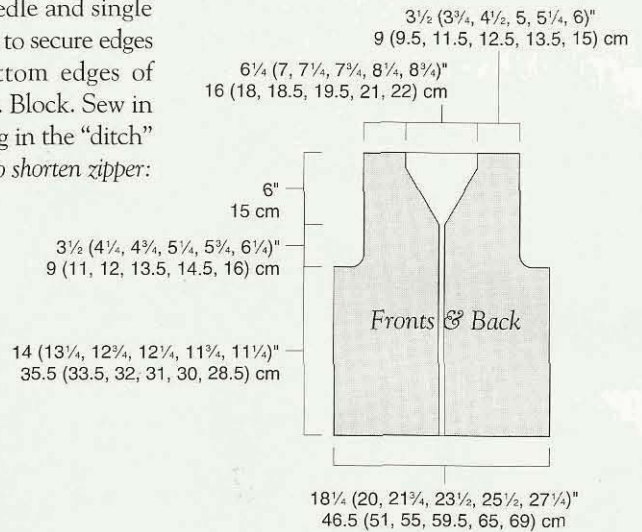
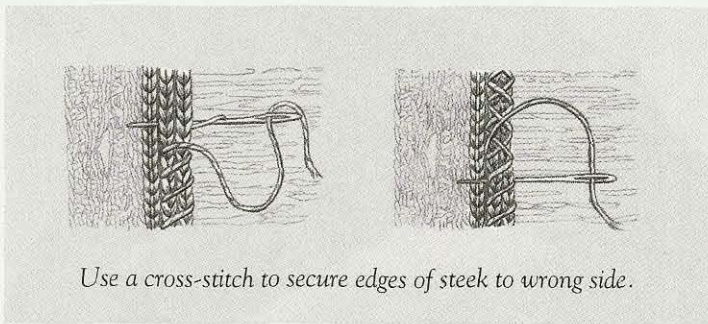

Feel like
playing with wool?



View www.baabajoeswool.com
at home, work, or library for store
locations and products.



Felt a wool hat • Have fun! • Wool Wash • Wool Pak Yarns NZ • Toys

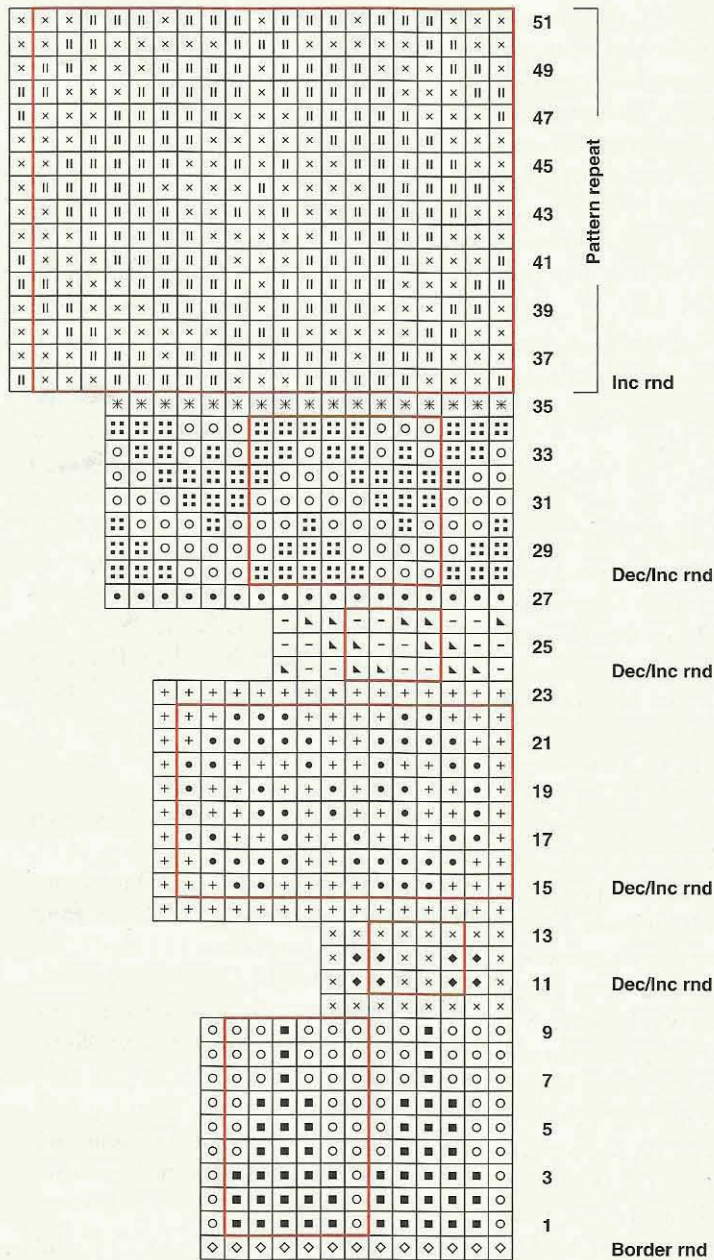

Green colorway/purple colorway

- sage/British blue
- ◆ teal/burgundy
- deerskin/teal
- ▴ boysenberry/British blue
- || sage/black
- ⋮ olive/olive
- pattern repeat
- ✱ black/burgundy
- dahlia/black
- × boysenberry/dahlia
- + black/evergreen
- sage/dahlia
- ◇ olive/black



Tahki
 Imports Ltd.

FARGO
 as featured in

TAHKI Essentials

Volume 1

To order your copy of Tahki Essentials, Volume 1, featuring 37 new designs, send a check or money order for \$10.99 to the address below. For the Tahki retailer nearest you, call 201-807-0070. Visit our Web site at www.tahki.com for a free Fargo Pattern. Tahki Yarns 11 Graphic Place, Moonachie, NJ 07074.



THE SANQUHAR

DONNA KAY

Three traditional patterns

Simple shape

FINISHED SIZE 37 (41½, 46¼, 51)" (94 [105.5, 117.5, 129.5] cm) bust/chest circumference. Sweater shown measures 41½" (105.5 cm).

YARN Reynolds Lite-Lopi (100% wool; 109 yd [100 m]/50g): #52 brown (MC), 7 (7, 8, 10) balls; #421 green (CC), 6 (6, 7, 9) balls.

NEEDLES Body and Sleeves—Size 8 (5 mm): 16" and 29" (40- and 80-cm) circular (cir). Ribbing—Size 6 (4 mm): 16" and 24" (40- and 60-cm) cir and double-pointed (dnp). Adjust needle sizes if necessary to obtain the correct gauge.

NOTIONS Markers (m); stitch holders; tapestry needle.

GAUGE 19 sts and 19 rows = 4" (10 cm) in color pattern on larger needles after blocking; 19 sts and 24 rows = 4" (10 cm) in St st.

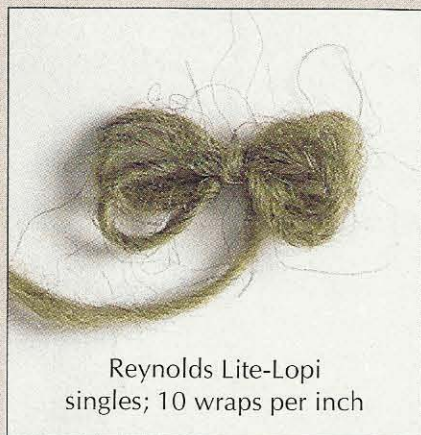

Reynolds Lite-Lopi singles; 10 wraps per inch

THE TIGHTLY KNIT, richly patterned gloves from the Scottish border area of Sanquhar were the inspiration for this sweater. These beautiful gloves were knitted for sale in that area throughout the nineteenth century. The patterns I've used here go by the names of "rose" and "shepherd's plaid." Worsted weight yarn and casual styling give the patterns a new look.

Note: Because the first and third sizes have an even number of pattern repeats, the two-stitch brown stripe will appear at the center front and center back.

•**Body:** With MC and 24" (60-cm) cir needle, CO 165 (185, 205, 225) sts. Place m and join, being careful not to twist sts. *Pattern set-up:* *K3, p2; rep from *. Join CC and work rib as foll:

Rnd 1: *K1 MC, k1 CC, k1 MC, k2 CC; rep from *.

Rnds 2 and 3: *K3 MC, p2 CC; rep from *.

Rnd 4: *K1 MC, k1 CC, k1 MC, p2 CC; rep from *.

Rep Rnds 2–4 three times more, then work Rnd 2—piece should measure about 2½" (6.5 cm) from beg. With MC only, knit 1 rnd, inc 5 (5, 5, 15) sts evenly spaced—170 (190, 210, 240) sts. Change to larger needle and knit 1 rnd. Work Chart A a total of 20 (20, 20, 30) rnds; piece should measure about 4¼ (4¼, 4¼, 6¼)" (11 [11, 11, 16] cm) from top of rib. Beg with Row 1, work Chart B, inc 6 (8, 10, 2) sts evenly spaced on the first rnd—176 (198, 220, 242) sts. Work Chart B until piece measures 10¼ (12½, 14, 15½)" (26 [31.5, 35.5, 39.5] cm) from top of rib, ending with Rnd 7 (17, 2, 22) of chart—29 (39, 46, 44) rnds of Chart B total, ending at m. **Divide for armholes:** Turn work (WS) and cont in patt, p88 (99, 110, 121) sts for back. Place rem 88 (99, 110, 121) sts on holder for

front. **Back:** Working back and forth in rows on 88 (99, 110, 121) back sts, cont in established patt until piece measures 18½ (20½, 23, 25¾)" (47 [52, 58.5, 65.5] cm) from top of rib, ending with Row 2 (13, 2, 2) of chart—68 (79, 90, 90) total rnds of Chart B have been worked; armhole should measure 8¼ (8¼, 9¼, 10¼)" (21 [21, 23.5, 26] cm). **Shape back neck:** (RS) Cont in patt, work 31 (36, 40, 45) sts, place center 26 (27, 30, 31) sts on holder for back neck, join new ball of each color and work rem 31 (36, 40, 45) sts. Working each side separately, dec 1 st at neck edge every other row 2 times—29 (34, 38, 43) sts rem each side. Cont in patt until armhole measures 9½ (9½, 10½, 11½)" (24 [24, 26.5, 29] cm), ending with Row 7 (18, 7, 7) of Chart B; piece should measure about 22¾ (25, 27, 29½)" (58 [63.5, 68.5, 75] cm) from beg. Place sts on holders. **Front:** Place 88 (99, 110, 121) held front sts on needle and join yarns. Beg with WS facing, cont with Chart B as for back until piece measures about 3¼ (3¼, 3¼, 3¼)" (8.5 [8.5, 9.5, 9.5] cm) less than total back length, ending with Row 14 (3, 11, 11) of chart—58 (69, 77, 77) total rows of Chart B have been worked. **Shape front neck:** Cont in patt across 37 (42, 47, 51) sts, place center 14 (15, 16, 19) sts on holder for front neck, join new yarns and work rem 37 (42, 47, 51) sts in patt. Working each side separately, dec at each neck edge 3 sts once, 2 sts once, then 1 st 3 (3, 4, 3) times—29 (34, 38, 43) sts rem each side. Work even until piece measures same as back to shoulders. Place sts on holders.

•**Sleeves:** With MC and dnp, CO 40 (40, 45, 45) sts. Divide sts evenly onto 3 dnp, place m, and join, being careful not to twist sts. Work rib patt as for body—piece should measure 2½" (6.5 cm) from beg. With MC only, knit 1 rnd, inc 13 (13, 14, 18) sts evenly spaced—53 (53, 59, 63) sts.

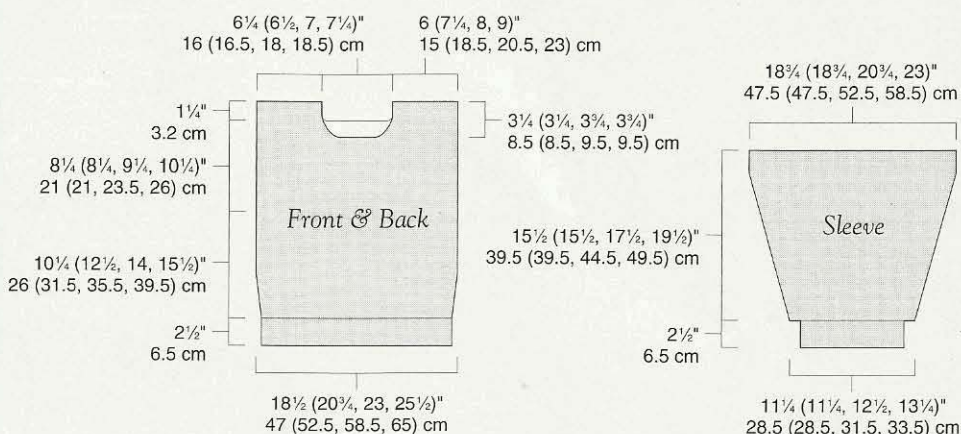

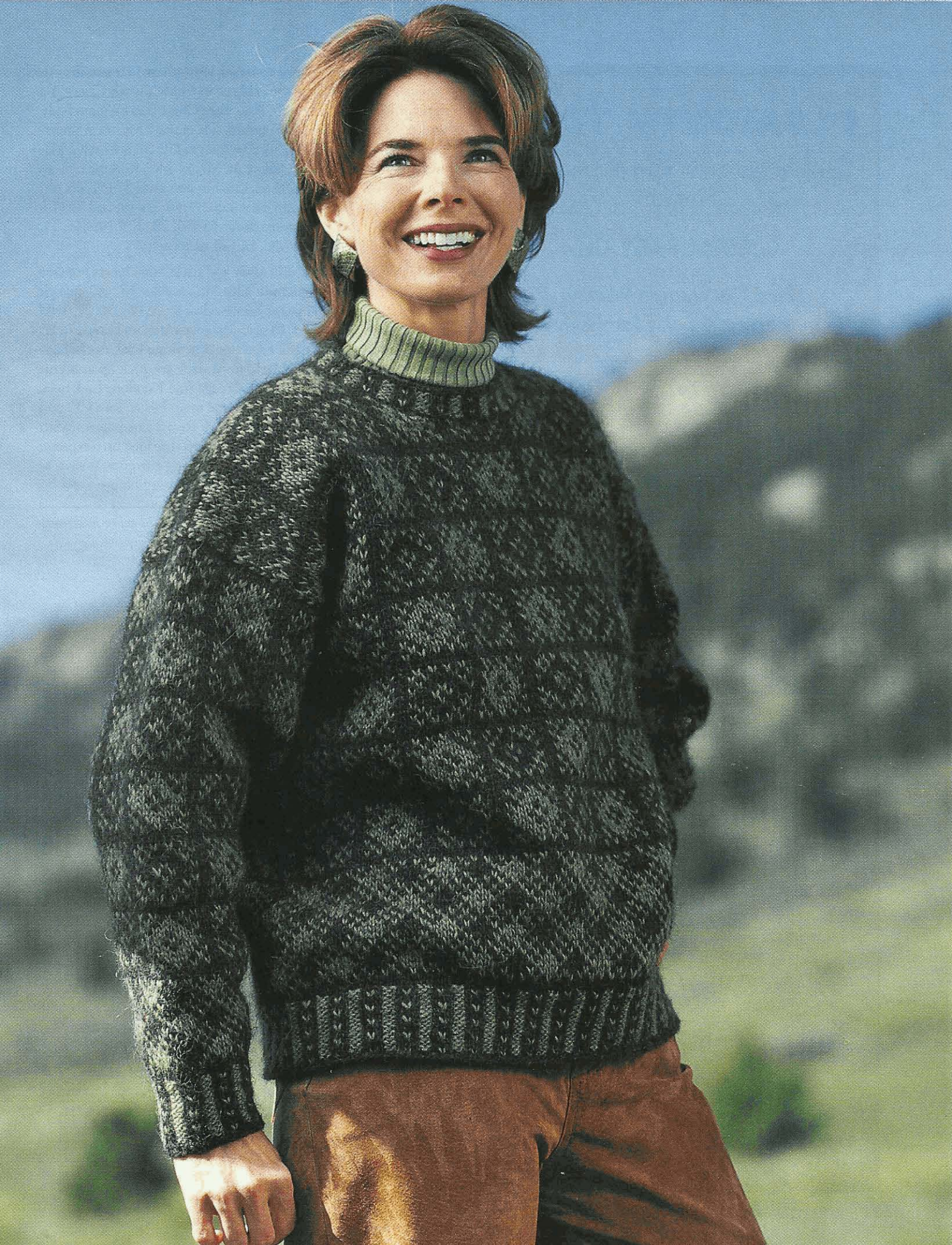

ARE YOU Y2K* PREPARED?!

(*yarn over knit two)

**Brittany Wood Knitting Needles
Not Just For Special Occasions
Definitely for the Millennium**

Brittany

fine wood knitting needles & crochet hooks
PO Box 130 Elk, California 95432
www.brittanyneedles.com brittany@mcn.org
888-488-9669



Try knitting with our
Forever Random® Blends
You'll LOVE working
with them...and your
piece will be unique!
Apache Plume
Cardigan Kit
by Valentina Devine
or check out
our website
for our
other
kits and
patterns
over 40
truly
random
colorways
FRB Sample
Cards \$10

www.taosfiber.com/lalana
Phone: 505-758-9631
888-377-9631
(Orders only please)
136 Pasco Norte
Taos, NM 87571

Photo, Lenny Foster

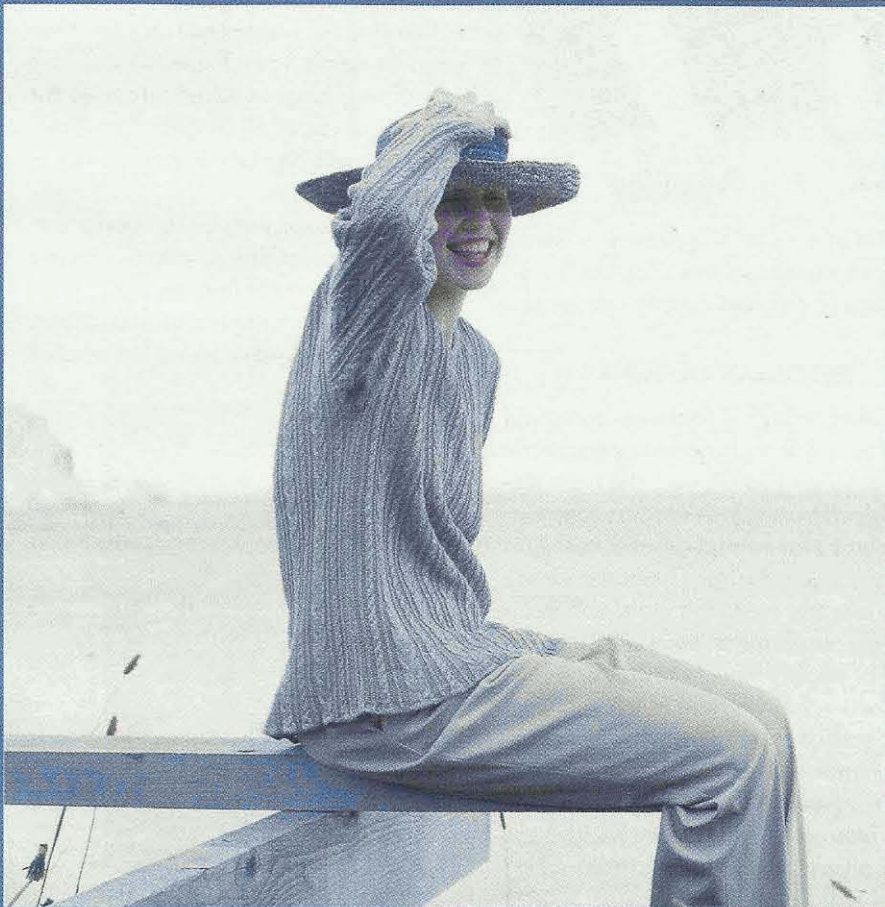

Euroflax 

100% LINEN YARN

New Designer Patterns

AVAILABLE IN
30 LUSTROUS COLORS



Colors are approximate

For Sample Cards & Info: **Louet Sales**
PO Box 267, Station KN, Ogdensburg, NY 13669



Wholesale Inquiries Welcome

Folk Knitting

IN ESTONIA

NANCY BUSH

*Adapted from her new book of the same title.
Available in November from Interweave Press.*

ONE CHARACTERISTIC that I find most charming in folk art is the *horror vacui*, or fear of empty space. The pattern motifs in Estonian knitting generally appear rather simple when examined individually. But together, either as a repeat, grouped in a stack, or extended, they can be very ornate. Many Estonian knitting patterns have evolved from other textiles, woven belts being the most obvious source, woven blankets and rugs being others.

Of the nearly 4,000 handknitted items in the Estonian Ethnographic Museum in Tartu, the majority are mittens, gloves, socks, and stockings dating to the nineteenth century. Many accession notes record that the last owner received the item as a gift during a wedding. The museum's collection is a wealth of pattern, technique, and symbolism, as well as a wonderful record of Estonian folk costume.

Up until the middle of the nineteenth century, when aniline dyes were introduced, Estonian dyes were created from plants, bark, or moss. Red came from field madder or goose-straw roots, yellow from birch leaves, yellow daisy, or chamomile, and green from maple leaves and heather. Brown was extracted from pinecones, alder bark, buckthorn, or cowberry stalks. Blue was the hardest color to achieve. Producing cobalt blue or pot blue, indigo used to make dye came from India or Africa, was expensive, and was therefore used in small amounts. The woad plant also yielded a blue dye and was much more available than indigo. Known throughout Europe and Scandinavia, woad was used for blue prior to and even after indigo became available. Cobalt green or pot green was obtained by first dyeing yarn green, then over-dyeing it with indigo. Another imported color was insect red or cochineal.

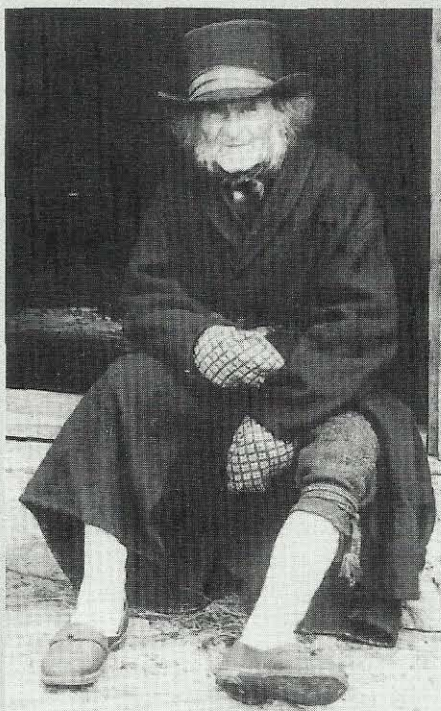

Many Estonian knitting patterns evolved from other textile sources. Note the braid-like design on this man's woven sock garters.

ESTONIAN DESIGNS

Most of today's Estonian mittens and gloves are made with two-color geometric designs. Mittens dating from the late nineteenth/early twentieth century may employ plant and animal designs based on older geometric forms. These designs are rather rare and are found mostly on items from Western Estonia, especially from the island of Muhu where bold aniline colors were used in knitting and in folk costume. In the rest of Estonia, even after the arrival of aniline dyes, colors remained subdued, the patterns worked in sheep's black or pot blue on a natural white background or the reverse. Sometimes knitters added a bit of red, green, or yellow.

The geometric elements—dots, squares, stars, crosses, and triangles—found on most Estonian knitting are taken from traditional folk designs. Some are connected to a magical past and carry strong meaning and power.

Knitters would see each other's designs during social times, at church, or at market. If one knitter wanted to borrow another's mitten to copy, the left hand only was lent, never the right one, because it was believed that without the right-hand mitten the knitter would lose the ability to make the pattern. Patterns also appeared in books and magazines, but not until the end of the nineteenth century.

I created the knitted bag on page 31 as a way to teach a few Estonian knitting techniques, most of which are used for knitting mitten or glove cuffs. I used two geometric and one lace pattern between the "cuff" elements.

The bag begins with Liidia's braid cast-on. Liidia lives on Kihnu, where I met her as she sat in front of her farm knitting a sleeve for a doll in the traditional pattern of a Kihnu Troi. I asked about her unusual



Detail of vikkel stocking from Muhu.

PHOTOGRAPH COURTESY OF ESTONIAN NATIONAL MUSEUM, TARTU.

PHOTOGRAPH COURTESY OF EESTI RAHVA MUSEUM, TARTU.

two-color cast-on, and this is what she taught me.

The next element in the bag is a two-color braid pattern known as *vikkel*. With possible ties to the German *zwickel* or “clock,” the pattern may refer to the clock designs on the sides of stocking ankles. Done in embroidery, this pattern was first popular for hiding seams in stockings cut and sewn from woven fabric. The decoration then transferred to knitted stockings and gloves and continued into this century when *vikkel* came to mean a solid-colored textured pattern where the stitches cross over each other one at a time. It could be worked over the entire body of an item or only in specific places. *Vikkel*-patterned gloves, whose popularity dates from the beginning of the nineteenth century, were more common than mittens and were mostly made with natural colored yarn—wool, cotton, or linen. Sometimes on the island of Muhu and in the parish of Paistu, the hand was made in *vikkel* and the cuff

was decorated with a variety of colors. *Vikkel* gloves often bore pattern only on the back of the hand and on one or two fingers and the thumb. These ornate gloves were worn mostly for festive occasions.

Special decorative cuffs came from the island of Kihnu, off the west coast near Pärnumaa. These cuffs had a braided cast-on and contained lateral braids known as *vits*, an Estonian word for the hoop on a wooden beer mug made like a cooper’s barrel. *Vits* were often used several times in a cuff, mixed with two-color patterning in simple shapes and diagonal lace stitches. Similar in appearance to the *vikkel* braid, *vits* are accomplished in a very different manner (see page 34).

While fringe is usually formed as part of a cast-on, I used it at the top end of the bag. A number of wonderful gloves in the Estonian National Museum have fringe at the base of the cuffs, with some fringes extraordinarily long and in several colors. Gloves with elaborate fringe were proba-

bly used only for festivals or weddings, because the fringe was impractical for work. Gloves with long fringe came from the island of Saaremaa. Others, from the area of Tostamaa and Tori near Parnu, have shorter fringe often worked into the cuff farther up from the edge.

I hope you enjoy learning these new techniques as much as I did, and that you’ll use them to add ethnic flare to your own original designs. ∞



PHOTOGRAPH COURTESY OF ESTONIAN NATIONAL MUSEUM, TARTU.

Gloves with elaborate fringe were probably reserved for festive occasions.

ESTONIAN-INSPIRED POCKET BAG

FINISHED SIZE 6" (15 cm) wide and 7¼" (19.5 cm) long, excluding shoulder strap.

YARN Berroco Bluefaced Leicester (100% wool; 103 yd [95 m]/50 g): #7001 natural, #7013 black, #7002 burgundy, 1 ball each.

NEEDLES Size 3 (3.25 mm): Set of 5 double-pointed (dnp). Adjust needle size if necessary to obtain the correct gauge.

NOTIONS Marker (m); tapestry needle; felt fabric for lining if desired.

GAUGE 12 sts and 16 rnds = 2" (5 cm) in pattern.

FROM THE TWO-COLOR braid cast-on to the braided shoulder strap, this little bag incorporates many traditional Estonian knitting techniques and patterns. It is worked in the round from the bottom up, sewn together at the bottom, and lined with felt. All the techniques are described in detail on pages 33 and 34. Practice them in this pocket bag, then use them to add ethnic flair to your own project.

With black and white and using Liidia’s braid method (see page 33), CO 73 sts. Divide sts evenly onto 4 dnp so that there



are 18 sts each on needles #1, #2, and #3, and 19 sts on needle #4. Join (being careful not to twist sts) by slipping the first CO st to right needle, binding the last CO st over it, and replacing the first st to left needle—18 sts each needle. Place m. Beg with Rnd 1, work as charted. On Rnd 4, work vikkel braid, ending rnd by passing the last st over the first (as for CO join). On Rnd 10, work vikkel braid with natural and black, ending rnd as before. On Rnd 18, work vikkel braid again with nat-

ural and black. On Rnd 22, work Vikkel braid with natural and burgundy. On Rnds 42 and 43, work Kihnu vits with natural and black. On Rnd 45, work three-color twist with natural, black, and burgundy. On Rnds 47 and 48, work Kihnu vits as before. On Rnd 57, work fringe st. BO all sts kwise, alternating natural and black with each knit st.

•**Finishing:** With yarn threaded on a tapestry needle, sew seam at CO edge. Make

an 8-strand braid for shoulder strap for desired length and attach it securely to the inside of the bag at each side (at beg of rnd and mid-point of rnd). Line bag with fabric if desired. ∞

Nancy Bush is a teacher, designer, writer, and retailer. Her first passion is knitting, her second is history, and the two are combined in her newest book, Folk Knitting in Estonia, available from Interweave Press in November.

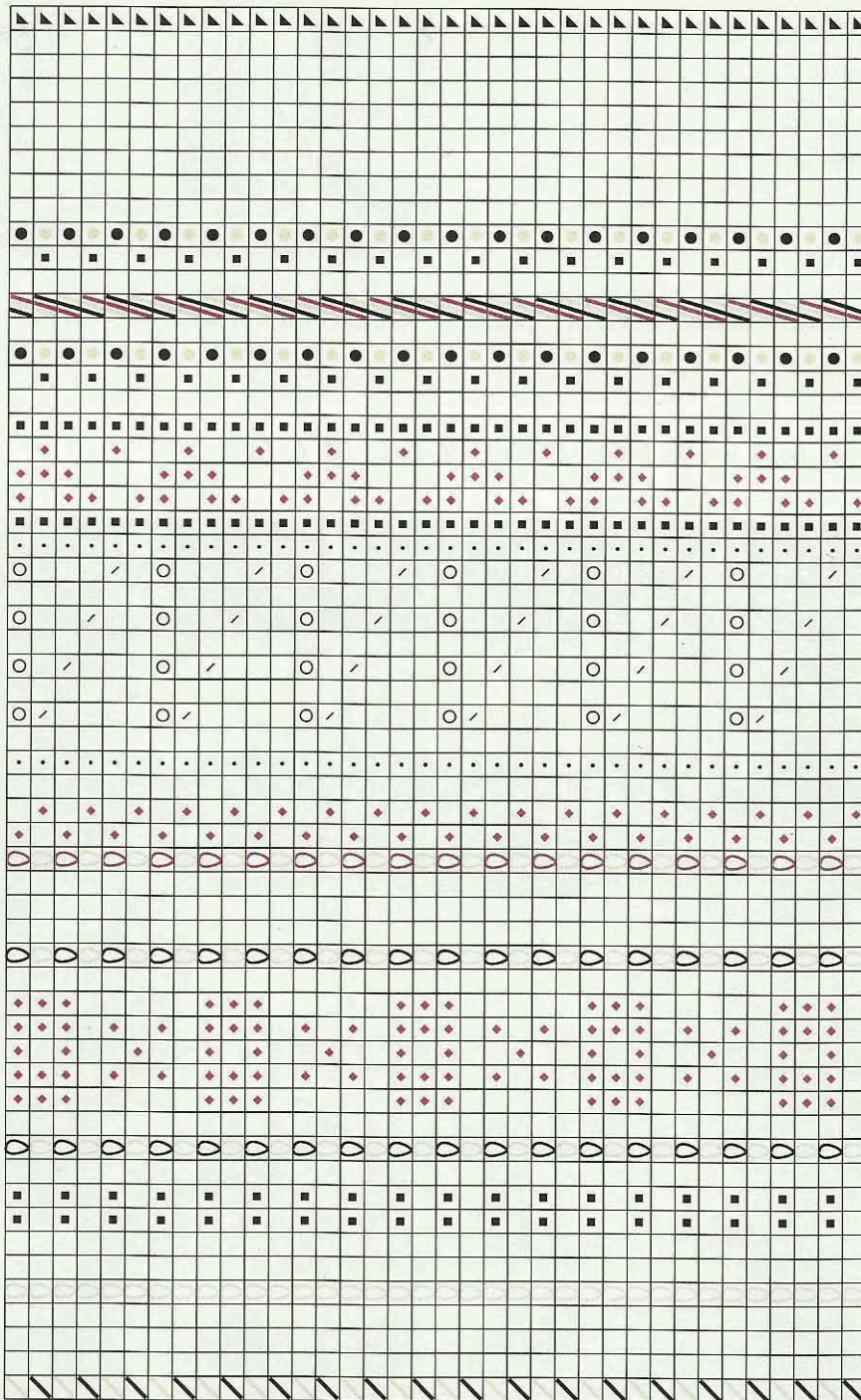

-  natural
-  black
-  burgundy
-  yo
-  k2tog
-  purl
-  fringe stitch
-  twisted braid—three colors
-  black—purl white st; bring color under waiting color
-  white—purl black st; bring color under waiting color
-  vikkel braid—one color
-  vikkel braid—two color
- Liidia's braid**
-  black—bring to front passing over the white yarn and knit
-  white—bring to front passing over the black yarn and knit

Techniques for Estonian Pocket Bag

Liidia's Braid Cast-On

Make a slip knot with 2 colors. (This knot is not included in the st count and will be dropped before sts are joined into a rnd.) Hold the two ends of yarn as shown, with the dark yarn over your index finger and the light yarn over your thumb (figure 1). CO 1 st (figure 2). *Bring the dark yarn to the front in position around your thumb, passing it over the light yarn, and put the light yarn to the back in position around the index finger (figure 3). CO 1 st (figure 4). Rep from *, switching colors with each st. Cast on an even number of sts plus 1 (this extra st will be the same color as the first CO st). At the end of the rnd, drop the slip knot off the needle. Divide sts evenly onto 4 dpn. Join work (being careful not to twist sts) by slipping the extra st onto the left needle and knitting it together with the first CO st.

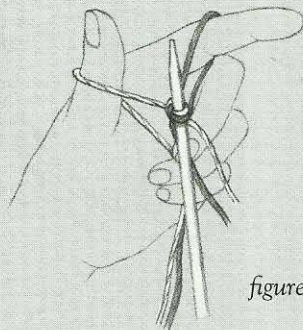

figure 1

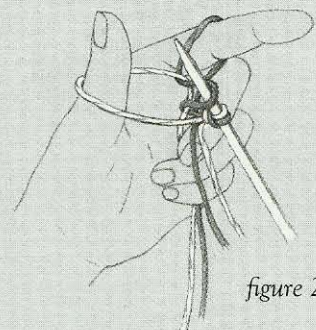

figure 2

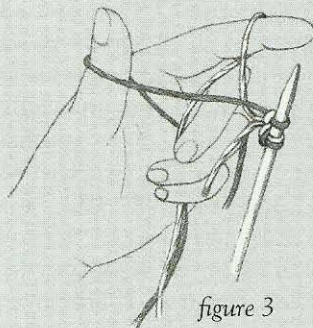

figure 3

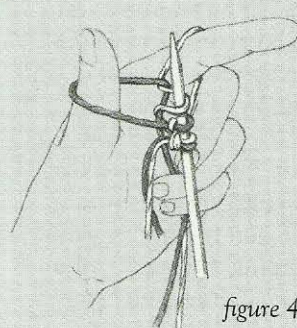

figure 4

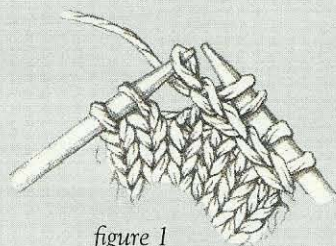

figure 1

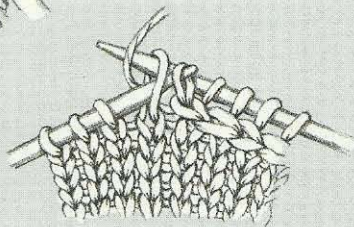

figure 2

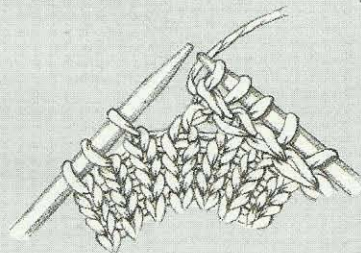
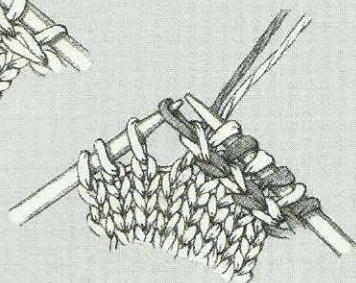

figure 3



Two-color vikkel

Vikkel Braid

Vikkel describes Estonian patterns made with stitches that cross over each other. These "traveling sts" are made without using a cable needle. I named this type of lateral braid *vikkel* because it is worked in a similar manner.

One-Color Vikkel Braid: Inc 1 st by picking up the bar between the last st worked and the next stitch and knit it tbl (M1). Place this st (think of it as st #1) onto the left needle. Now knit tbl into the st to the left of the #1 st (going behind #1), then knit the #1 st as usual. Sl both sts off needle. *Replace st closest to right needle point onto left needle (figure 1), knit into second st tbl (figure 2), then knit 1st st as usual. Drop both sts off left needle (figure 3). Rep from *. On last st, take it over the first st (as to bind off) to get back to required stitch count. Remember to always drop both sts after they are worked.

Two-Color Vikkel Braid: Work as for one-color braid, but beg by using CC in the lifted st. Then, after replacing it back to the left needle, k1 tbl into the second st with CC1 and knit into the first st with MC. Drop both sts off. Cont in this manner, switching MC and CC every 2 sts. End as above to get back to the required st count. *Tip:* The color you use when you knit into the back of the st is the same color as the st you just transferred. The transferred st is knitted with the other color.

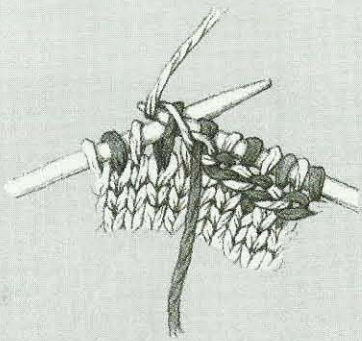

Kihnu Vits

Kihnu Vits or Kihnu braid or band. *Vits* means a hoop or a band, in this case one that circles the cuff of a mitten or the leg of a sock.

Rnd 1: *K1 CC, k1 MC; rep from *.

Rnd 2: Bring both colors to the front as to purl, *purl the CC st with MC, purl the MC st with CC, bringing the new color under the old. Rep from *.

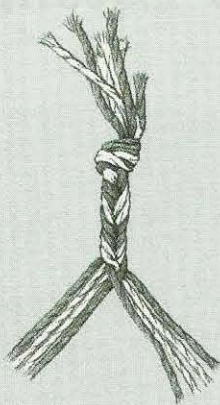

Eight-Strand Braid

Cut 4 lengths of CC and 4 lengths of MC, each about 25 percent longer than desired finished length. Tie them together in an overhand knot. Set them up so you have, from left to right, CC, CC, MC, MC, MC, MC, CC, CC. *Bring the outer yarn from each side to the center, laying the right yarn under the left. Rep from *, bringing the two outer threads to the center and laying the right thread under the left one. Tighten as you work to give the braid an even appearance.

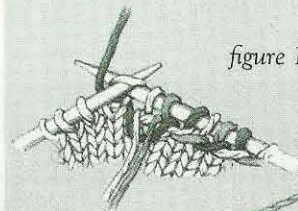

figure 1

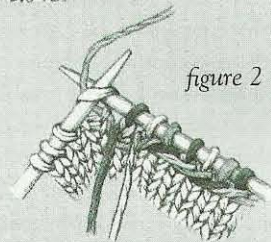

figure 2

Three-Color Twist

*With colors #2 and #3 forward, k1 with color #1 then bring this color forward as to purl. Bring color #2 under #1, take #2 to the back (as to knit), and k1 (figure 1). Now bring this yarn forward as to purl. Bring color #3 under #2, take #3 to the back and k1 (figure 2). Now bring this thread forward as to purl. Rep from *, using each color in order, always bringing the next color *under* the last one used.

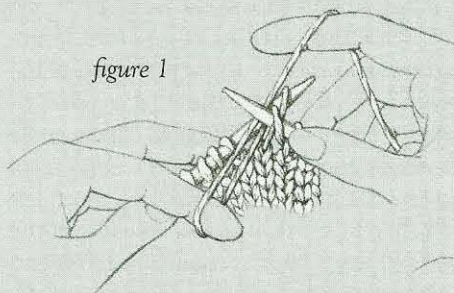

figure 1

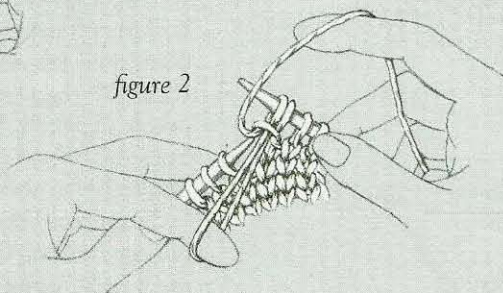

figure 2

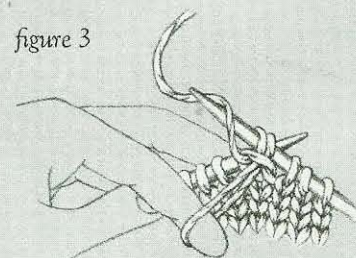
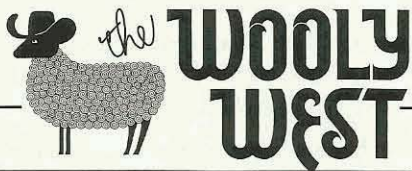

figure 3

Fringe Stitch

This fringe is made in the body of the fabric. Bring yarn forward as to purl. Place right needle into next st as to purl. Wrap the working yarn around the needle pwise, then before pulling the yarn through to finish the st, bring it down and around a ruler or your left index finger (figure 1). Catch the yarn coming upward from this motion behind the needle point, and pull both parts of the loop through the st (figure 2). You now have a new st consisting of 2 loops, on the right needle. Sl this double loop back onto the left needle, insert the right needle into it from right to left (pwise) and purl it (figure 3).



**Fine natural
fiber yarns and
accessories for
handknitters**

*We specialize in
small projects!*

*Everything from
yarns and patterns
to books and needles.*

Mailorder Catalog or

Check our website:
www.woollywest.com

1417 South 1100 East
Salt Lake City, UT 84105
(801) 487-9378

Halcyon Yarn

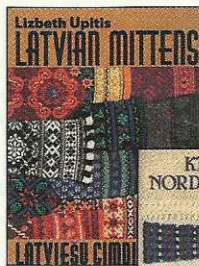

15% Off!
Books & Magazines

When you buy
5 or more—
Always!

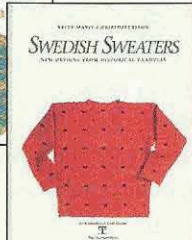
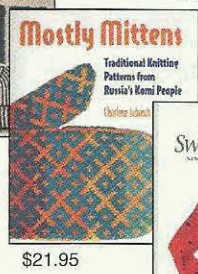

Peace Fleece
Russian/American
hand painted needles
\$6.50

Free Catalog
1-800-341-0282

12 School St. • Bath, ME 04530
www.halcyonyarn.com

FREE

Berroco Newsletter with Patterns

Receive Berroco's newsletter **Update** and ...
• Receive free Update patterns
• Learn about our newest yarns and patterns
• Preview the latest fashion trends
• Best of all — it's FREE.

If you are already a subscriber, there is no need to respond. You'll automatically receive our upcoming issues.



Name: _____
Address: _____
City: _____
State: _____ Zip: _____

Mail to: Berroco, Inc., Dept. IF99,
PO Box 367, Uxbridge, MA 01569-0367

BERROCO

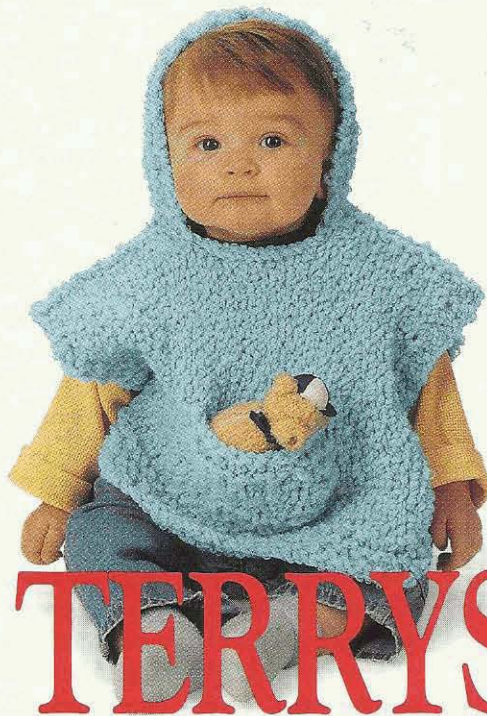

A soft, textured yarn,
perfect for afghans
and great fashions.

Available at leading
yarn and craft stores.

TERRYS-PUN

"FAMOUS FOR QUALITY SINCE 1878"

LION BRAND YARNS

34 W. 15TH ST., DEPT. IK, NY, NY 10011 1-800-258-YARN(9276) <http://www.lionbrand.com>
Mail-in: Crochet Pattern #820A or Knit Pattern #819A, \$2.50. Color card with 9 colors, CC970 \$2.95.



HUNGARIAN RHAPSODY

HEATHER LODINSKY

Slip-stitch patterning

Embroidered details

FINISHED SIZE 35 (38, 41, 44, 47)" (89 [96.5, 104, 112, 119.5] cm) bust/chest circumference, buttoned. Sweater shown measures 38" (96.5 cm).

YARN Rowan Designer DK Wool (100% wool; 126 yd [115 m]/50 g): #637 maroon, 6 (6, 7, 8, 8) balls; #62 black, 7 (7, 8, 9, 10) balls. Rowan Light DK (100% wool; 73 yd [67 m]/50 g): #42 red, #72 gold, #73 dark green, #37 light green, 1 ball each.

NEEDLES Body—Size 6 (4 mm): (60-cm) circular (cir); Edging—Size 4 (3.5 mm): 24" (60-cm) cir. Adjust needle sizes to obtain the correct gauge.

NOTIONS Stitch markers (m); tapestry needle; seven ½" [1.3-cm] buttons.

GAUGE 24 sts and 30 rows = 4" (10 cm) in St st on larger needle; 24 sts and 60 rows = 4" (10 cm) in mosaic patt on larger needle.



Rowan Designer DK
4-ply; 12 wraps per inch

THE COLORS of Hungarian embroidery are dramatic and its floral motifs are cheerful. In creating a cardigan to mimic the best of Hungarian embroidery, I used a floral border inspired by the gorgeous satin stitch of world-famous Kalocsa Embroidery. To honor Hungarian cross-stitch, another popular technique, I revised a pattern from Barbara Walker's book *Mosaic Knitting* to make it appear as flowers do in cross-stitch. The mosaic knitting and stem stitching give this cardigan just the texture it needs to appear embroidered. While the black background is dramatic, a white background would be equally beautiful for your own Magyar mosaic!

•**Back:** With maroon and smaller needle, CO 107 (115, 123, 131, 139) sts. **Corrugated ribbing:** (set-up row) K1 maroon, *k1 black, k1 maroon; rep from * to end. **Row 1:** (WS) P1 maroon, *k1 black, p1 maroon; rep from *.

Row 2: K1 maroon, *p1 black, k1 maroon; rep from *.

Rep Rows 1 and 2 for a total of 7 rows, ending with Row 1. Change to larger needle and with maroon, knit 2 rows (1 garter ridge). **Border:** With black, work 4 rows St st (knit on RS; purl on WS). **Next row:** (RS) With black, k2 (6, 10, 14, 18), pm, work Row 1 of Back Border chart as specified over next 103 sts, pm, k2 (6, 10, 14, 18) with black. Cont through Row 20 of chart, working sts outside ms in St st in black. With black, work 4 rows St st. With maroon, knit 2 rows (1 garter ridge). With black, knit 2 rows (1 garter ridge). **Mosaic patt:** Beg with Row 1, and always knitting the first and last st (edge st) of each row in color used on that row, work mosaic patt (see page 38) until piece measures 10½ (10½, 11, 11, 11½)" (26.5 [26.5, 28, 28, 29] cm) from beg, ending with a WS row. **Shape armholes:** BO 5 (6, 7, 8, 9) sts at beg of next 2 rows, 2 sts at the beg of foll 4 rows, then 1 st at beg of foll 4 rows—85 (91, 97, 103, 109) sts rem. Cont as established until armhole measures 5 (5½, 6, 6½, 6½)" (12.5 [14, 15, 16.5, 16.5] cm), ending with a WS row. **Shape neck:** Work 35 (38, 41, 44, 47) sts in patt, join new yarn and BO center 15 sts, work to end of row. Working each side separately and keeping in patt, at neck edge BO 5 sts once, 4 sts once, 3 sts twice, 2 sts 3 times, and 1 st 5 times—9 (12, 15, 18, 21) sts rem

each side. Work even until armhole measures 8 (8½, 9, 9½, 9½)" (20.5 [21.5, 23, 24, 24] cm). BO all sts.

•**Left Front:** With maroon and smaller needle, CO 51 (55, 59, 63, 67) sts. Work corrugated ribbing as for back. Change to larger needle and with maroon only, knit 2 rows. With black, work 4 rows of St st, ending with a WS row. **Border:** With black, k2 (4, 6, 8, 10), pm, work Row 1 of Left Front Border chart, pm, k2 (4, 6, 8, 10) with black. Cont as for back until piece measures 10½ (10½, 11, 11, 11½)" (26.5 [26.5, 28, 28, 29] cm) from beg, ending with a WS row. **Shape armhole:** (RS) BO 5 (6, 7, 8, 9) sts at beg next row and then at arm edge BO 2 sts twice and 1 st twice—40 (43, 46, 49, 52) sts rem. Cont in patt until armhole measures 3 (3½, 4, 4½, 4½)" (7.5 [9, 10, 11.5, 11.5] cm), ending with a RS row. **Shape neck:** (WS) At neck edge, BO 5 sts twice, 4 sts once, 3 sts twice, 2 sts 3 times, and 1 st 5 times—9 (12, 15, 18, 21) sts rem. Work even until piece measures same as back to shoulders. BO all sts.

•**Right Front:** Work as for left front, reversing shapings and following Right Front Border chart.

•**Sleeves:** With maroon and smaller needle, CO 49 (49, 53, 53, 57) sts. Work ribbing as for back. Change to larger needle and knit 2 rows with maroon. With black, work 4 rows St st, inc 4 sts evenly across 1st row—53 (53, 57, 57, 61) sts. **Next row:** With black, k14 (14, 16, 16, 18), pm, work Row 1 of Sleeve Border chart over 25 sts, pm, k14 (14, 16, 16, 18) with black. Cont through Row 12 of chart, ending with a WS row. With black, work 4 rows St st. With maroon, knit 2 rows. With black, knit 2 rows. Work mosaic patt as for back, and *at the same time*, inc 1 st each end of needle every 6 rows 19 (21, 21, 23, 23) times—91 (95, 99, 103, 107) sts. Work even in patt until sleeve measures 14½ (15, 15, 15½, 15½)" (37 [38, 38, 39.5, 39.5] cm), ending with a WS row. **Shape cap:** BO 5 (6, 7, 8, 9) sts at beg of next 2 rows, 2 sts at beg of foll 4 rows, 1 st at beg of foll 4 rows—69 (71, 73, 75, 77) sts rem. Dec 1 st each end of needle every 4 rows 16 times—37 (39, 41, 43, 45) sts rem. BO 5 sts at beg of next 4 rows—17 (19, 21, 23, 25) sts rem. BO all sts.

•**Finishing:** With yarn threaded on a tapestry needle, sew shoulder seams. **Yoke:** With black, larger needle, and RS facing,



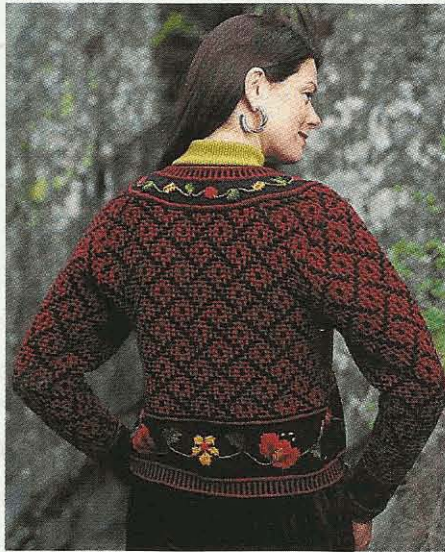

pick up and knit 50 sts along right front neck, 84 sts across back neck, and 50 sts along left front neck—184 sts. Knit 1 (WS) row. With maroon, knit 2 rows

(1 garter ridge). With black, knit 1 row. Next row: (WS) With black, *p3, p2tog; rep from *, end p4—148 sts. Next row: (RS) With black, k6, pm, work Row 1 of Yoke chart over 136 sts, pm, k6 with black. Working first and last sts in St st, work through Row 8 of chart on 136 center sts. With black, knit 1 row (RS). Next row: (WS) *P2, p2tog; rep from *—111 sts. With maroon, knit 2 rows. Change to smaller needle and starting with set-up row, work corrugated ribbing for ¼" (2 cm), ending with a WS row. BO all sts pwise. With yarn threaded on a tapestry needle, sew sleeves into armholes. Sew side and underarm seams. **Buttonband:** With maroon, smaller needle, RS facing, and beg at neck edge, pick up and knit 101 (105, 109, 111, 115) sts along left front. Knit 1 (WS) row. Work corrugated ribbing as for back for 1" (2.5 cm), ending with WS row. With maroon, knit 1 row. BO all sts pwise.

Mark placement of 7 buttons, one ½" (1.3 cm) from lower edge, one ½" (1.3 cm) from neck edge, and the other 5 evenly spaced in between. **Buttonhole band:** Work on right front as for buttonband, working buttonholes 3 rows from pick-up edge on RS rows opposite markers as foll: k2tog, yo. **Embroidery:** With single strand of light green threaded on a tapestry needle, work stem st as shown on charts. For larger sizes, extend stem-st vine to beyond edge flowers on fronts and back. Work single-strand French knots for the neckband motif and double-strand French knots on the back, fronts, and sleeves. ∞

Heather Lodinsky is not Hungarian, but her husband's family is proud of their Hungarian heritage. A few gifts from family members introduced Heather to Hungarian embroidery. This cardigan is a tribute to all those who carry on the tradition and art of Hungarian embroidery today.

Mosaic Chart

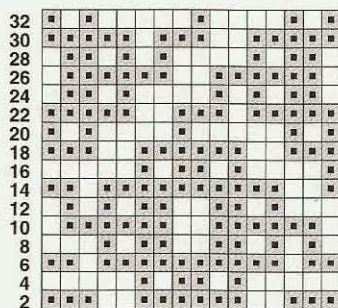

color bar

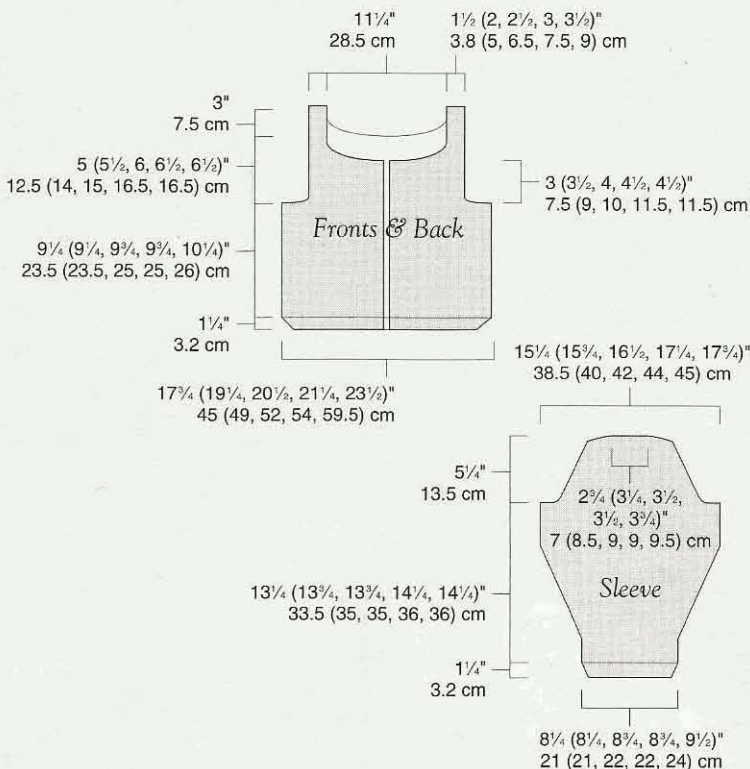

HOW TO READ A MOSAIC KNITTING CHART

1) Each row of a mosaic chart represents two rows of knitting. The first row is read from right to left and the second is read from left to right. The color bar to the right of the chart shows the "working" color for that row. In mosaic knitting, only one color is worked at a time across any row.

2) Always knit the first and last (edge) stitch of every row with your working color. The stitches in between these stitches form the repeat pattern. On the first row, which is maroon, knit the first stitch, and all the other stitches that are designated maroon in the chart. Where there are black stitches, keep your yarn to the back of your work and slip these black stitches purlwise. Make sure to knit the last stitch of the row in maroon. On the second row, knit the first stitch, and again knit all the maroon stitches, but this time when slipping the black stitches, bring your working yarn to the front. This keeps all the yarn floats at the back of the work. Again, knit the last stitch of your second row in maroon.

3) Because the pattern repeat doesn't fit evenly into the number of stitches on your needles, it is important to keep track of your last stitch in the repeat pattern (it will be the second-to-last stitch on right-side rows). You may find it helpful to mark the stitch on the chart where you have ended the pattern repeat so you will know where to begin the following row.

4) Work rows 3 and 4 like the previous two rows, but use black to knit the black stitches and slip the maroon stitches. Alternate every two rows with maroon and black to form the mosaic pattern.

Back Border

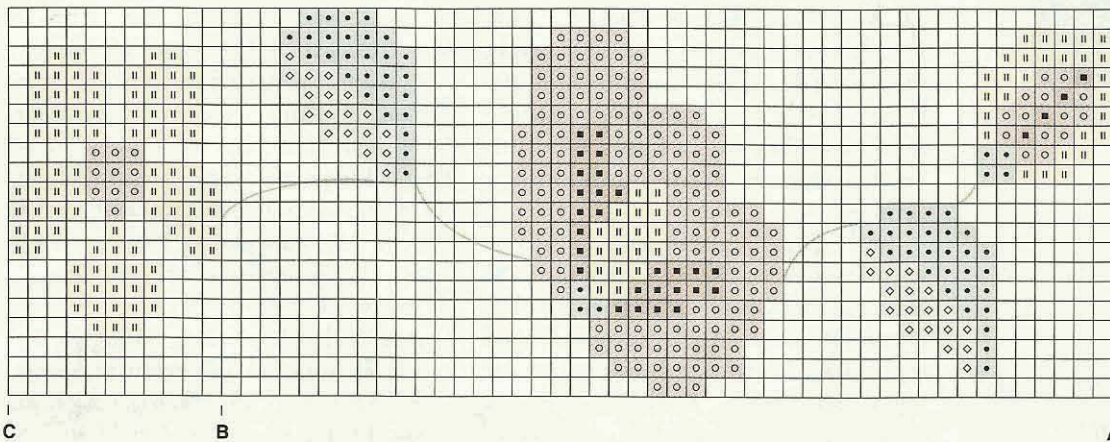

- black
- maroon
- red
- II gold
- dark green
- ◇ light green
- French knot

Work from A to C; then from B to A.

Left Front Border

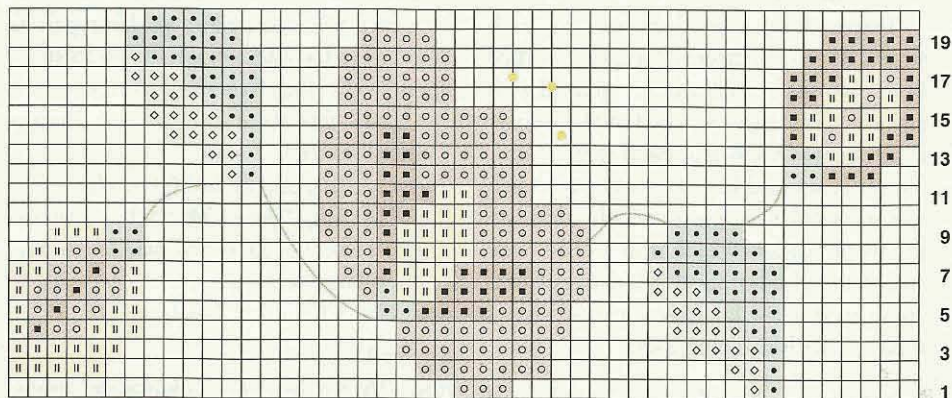

Right Front Border

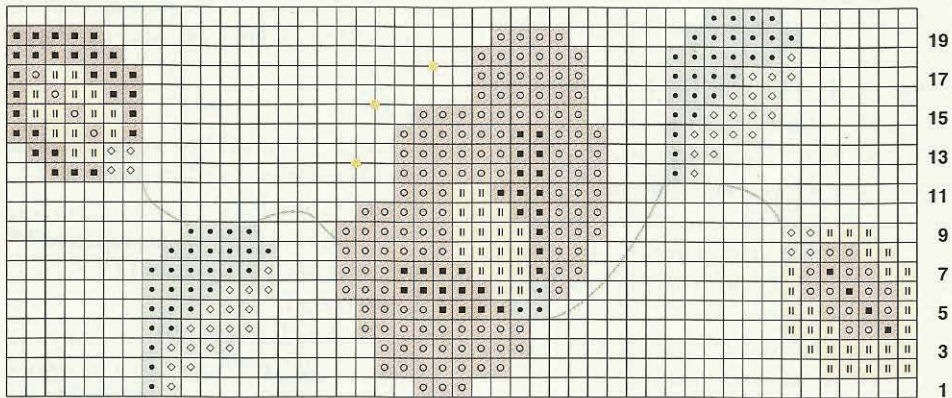

Sleeve Border

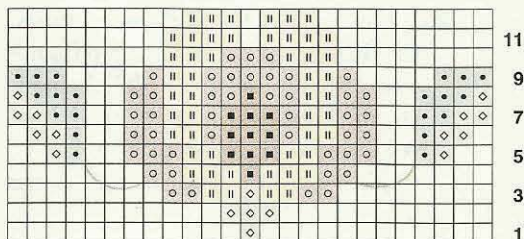

Yoke

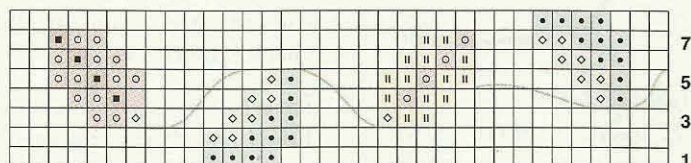

Stem Stitch

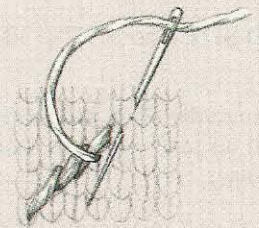

Bring threaded needle out from back to front at the center of a knitted stitch.
*Insert the needle into the upper right edge of the next stitch to the right, and then out again at the center of this same stitch. Repeat from *, working regular, slightly slanted stitches.

French Knot

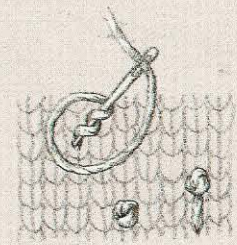

Bring needle out of the knitted background from back to front, wrap yarn around needle one to three times, and use your thumb to hold it in place as you pull needle through the wraps into the background a short distance (one background thread) from where the thread first emerged.



IRISH DIAMOND SHAWL

CHERYL OBERLE

Preview pattern from Folk Shawls

FINISHED SIZE About 52" (132 cm) square.

YARN Harrisville Shetland (100% wool; 440 yd [402 m]/4 oz): hemlock, 5 skeins.

NEEDLES Size 7 (4.5 mm): 24" or 29" (60-cm) circular (cir). Adjust needle size if necessary to obtain the correct gauge.

NOTIONS Stitch markers (m); tapestry needle.

GAUGE 16 sts and 24 rows = 4" (10 cm) in St st, very loosely knit.

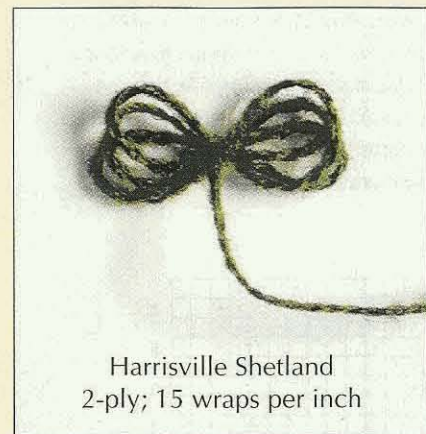

Harrisville Shetland
2-ply; 15 wraps per inch

ACCORDING TO Irish folklore, if a master knitter places knitting needles in a newborn baby's hands, the child will acquire a talent for knitting. Female babies were often given knitting needles so they would have skills with which to help support themselves and their families.

In the late nineteenth century, a conscientious mother discovered that the local master knitter was reluctant to pass on her talents. To convince her, the mother plied the elderly knitter with home-brewed liquor called *potteen*. By the time the old woman had consented, she was so tipsy that she put the knitting needles in the baby's left hand. Although right-handed in everything else, the baby grew into a left-handed knitter.

Inspired by a modern woven Irish shawl, this lace-patterned shawl is worked from the neckband down. It is shaped with yarnover increases worked at the center front, center back, and each side "seam." The first six and last six stitches of each row are worked in garter stitch and form the front border (which mimics the neck and lower edge borders). The lace patterns are worked in the large sections and do not interfere with the increases.

Note: Only right-side (even-numbered) rows are charted.

Neckband: CO 74 sts.

Row 1 and all odd-numbered rows: (WS) Knit.

Row 2: (RS) K6, pm, [yo, k14, yo, pm, k2, pm] 3 times, yo, k14, yo, pm, k6—82 sts. (Note: The ms indicate the corners of the shawl and should be slipped on all rows. The 2 corner sts bet the ms are maintained throughout. The yo incs and lace patts are worked in the 4 large sections bet ms.)

Row 4: K6, [yo, k16, yo, k2] 3 times, yo, k16, yo, k6—90 sts.

Row 6: K6, [yo, k18, yo, k2] 3 times, yo, k18, yo, k6—98 sts.

Row 8: K6, [yo, k20, yo, k2] 3 times, yo, k20, yo, k6—106 sts. This completes the neckband.

Note: From this point forward, you have the option of following the written or charted directions.

Lace 1:

Row 1 and all odd-numbered rows: (WS)

K6 (border sts), purl to last 6 sts, k6 (border sts).

Row 2: K6, [yo, k3, *k3, yo, ssk, k3; rep from * to 3 sts before next m, k3, yo, k2 (corner sts)] 3 times, yo, k6, **yo, ssk, k6; rep from **, to last 6 sts, yo, k6—114 sts.

Row 4: K6, [yo, k4, *k1, k2tog, yo, k1, yo, ssk, k2; rep from * to 4 sts before m, k4, yo, k2] 3 times, yo, k5, **k2tog, yo, k1, yo, ssk, k3; rep from ** to last 9 sts, k3, yo, k6—122 sts.

Row 6: K6, [yo, k5, *k2tog, yo, k3, yo, ssk, k1; rep from * to 5 sts before m, k5, yo, k2] 3 times, yo, k5, **k2tog, yo, k3, yo, ssk, k1; rep from ** to last 11 sts, k5, yo, k6—130 sts.

Row 8: K6, [yo, k6, *k2, yo, sl 2tog kwise, k1, p2sso, yo, k3; rep from * to 6 sts before m, k6, yo, k2] 3 times, yo, k8, **yo, sl 2tog kwise, k1, p2sso, yo, k5; rep from ** to last 10 sts, k4, yo, k6—138 sts.

Rows 9–112: Rep Rows 1–8 thirteen more times—554 sts after Row 112; 15 diamond motifs.

Row 113: K6, purl to last 6 sts, k6.

Row 114: K6, [*yo, k134, yo, k2] 3 times, yo, k134, yo, k6—562 sts; 136 sts in each large section.

Row 115: K6, purl to last 6 sts, k6.

Eyelet 1:

Row 116: K6, [yo, k1, (yo, k2tog) 67 times, k1, yo, k2] 3 times, yo, k1, [yo, k2tog] 67 times, k1, yo, k6—138 sts each large section.

Row 118: K6, [yo, k138, yo, k2] 3 times, yo, k138, yo, k6—140 sts each large section.

Lace 2:

Row 120: K6, [yo, k4, *yo, ssk, k7, k2tog, yo, k1; rep from * to 4 sts before m, k4, yo, k2 (corner sts)] 3 times, [yo, k4, **yo, ssk, k7, k2tog, yo, k1; rep from ** to last 10 sts, k4, yo, k6—142 sts each large section.

Row 122: K6, [yo, k5, *k1, yo, ssk, k5, k2tog, yo, k2; rep from * to 5 sts before m, k5, yo, k2] 3 times, yo, k5, **k1, yo, ssk, k5, k2tog, yo, k2; rep from ** to last 11 sts, k5, yo, k6—144 sts each large section.

Row 124: K6, [yo, k6, *(yo, ssk) 2 times, k3, (k2tog, yo) 2 times, k1; rep from * to 6 sts before m, k6, yo, k2] 3 times, yo, k6, ***(yo, ssk) 2 times, k3, (k2tog, yo) 2 times, k1; rep from ** to last 12 sts, k6, yo, k6—146 sts each large section.





Row 126: K6, [yo, k7, *k1, (yo, ssk) 2 times, k1, (k2tog, yo) 2 times, k2; rep from * to 7 sts before m, k7, yo, k2] 3 times, yo, k7, **k1, (yo, ssk) 2 times, k1, (k2tog, yo) 2 times, k2; rep from ** to last 13 sts, k7, yo, k6—148 sts each large section.

Row 128: K6, [yo, k8, *yo, (ssk, yo) 2 times, sl 1 kwise, k2tog, pssso, (yo, k2tog) 2 times, yo, k1; rep from * to 8 sts before m, k8, yo, k2] 3 times, yo, k8, **yo, (ssk, yo) 2 times, sl 1 kwise, k2tog, pssso, (yo, k2tog) 2 times, yo, k1; rep from ** to last 14 sts, k8, yo, k6—150 sts each large section.

Row 130: K6, [yo, k9, *k3, k2tog, yo, k1, yo, ssk, k4; rep from * to 9 sts before m, k9, yo, k2] 3 times, yo, k9, **k3, k2tog,

yo, k1, yo, ssk, k4; rep from ** to last 15 sts, k9, yo, k6—152 sts each large section.

Row 132: K6, [yo, k10, *k2, k2tog, yo, k3, yo, ssk, k3; rep from * to 10 sts before m, k10, yo, k2] 3 times, yo, k10, **k2, k2tog, yo, k3, yo, ssk, k3; rep from ** to last 16 sts, k10, yo, k6—154 sts each large section.

Row 134: K6, [yo, k11, *k1, (k2tog, yo) 2 times, k1, (yo, ssk) 2 times, k2; rep from * to 11 sts before m, k11, yo, k2] 3 times, yo, k11, **k1, (k2tog, yo) 2 times, k1, (yo, ssk) 2 times, k2; rep from ** to last 17 sts, k11, yo, k6—156 sts each large section.

Row 136: K6, [yo, k12, *(k2tog, yo) 2 times, k3, (yo, ssk) 2 times, k1; rep from

Eyelet 2

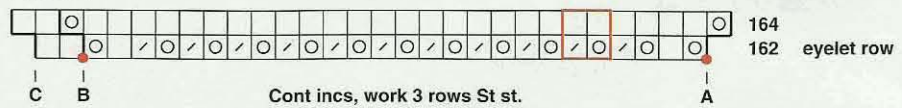

Lace 2

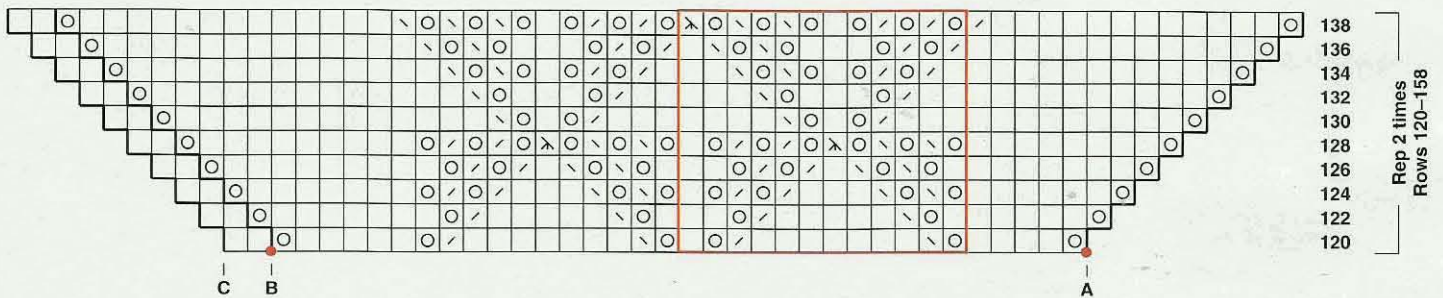

Eyelet 1

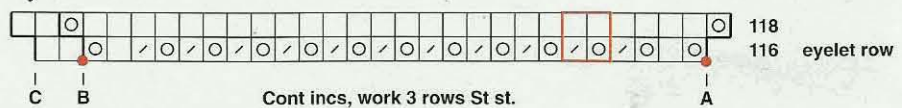

Lace 1

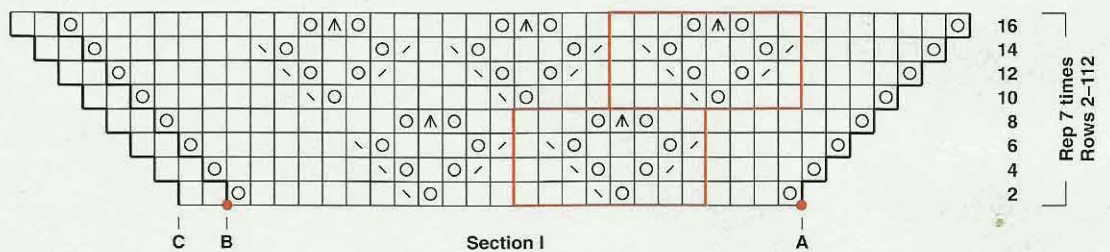

- k on RS; p on WS
- \ ssk
- / k2tog
- yo
- ^ dbl dec: sl 2tog kwise, k1, p2sso
- λ dbl dec: sl 1 kwise, k2tog, pssso
- pattern repeat
- marker (m)

The shawl is composed of 4 sections. Section I is shown. Directions below complete all 4 sections. All odd rows: K6, purl to last 6 sts, k6. These rows are not shown on charts. All even rows: K6, rep from A to C of Lace 1 chart 3 times, then work from A to B once, k6. Continue with Lace 1 chart until there are 15 diamonds (highlighted box) in each section. Work Lace 1 chart, 3 rows St st, Eyelet 1 chart, Lace 2 chart, 3 rows St st, Eyelet 2 chart.

* to 12 sts before m, k12, yo, k2] 3 times, yo, k12, ******(k2tog, yo) 2 times, k3, (yo, ssk) 2 times, k1; rep from ****** to last 18 sts, k12, yo, k6—158 sts each large section.

Row 138: K6, [yo, k12, k2tog, *(yo, k2tog) 2 times, yo, k1, (yo, ssk) 2 times, yo, sl 1 kwise, k2tog, pss0; rep from * to 25 sts before m, (yo, k2tog) 2 times, yo, k1, (yo, ssk) 3 times, k13, yo, k2] 3 times, yo, k12, k2tog, ******(yo, k2tog) 2 times, yo, k1, (yo, ssk) 2 times, yo, sl 1 kwise, k2tog, pss0; rep from ****** to last 31 sts, (yo, k2tog) 2 times, yo, k1, (yo, ssk) 3 times, k13, yo, k6—160 sts each large section.

Rows 140–158: Rep Rows 120–138—180 sts each large section after Row 158.

Row 160: K6, [yo, k180] 4 times, yo, k6—182 sts each large section.

Eyelet 2:

Row 162: K6, yo, [k1, *yo, k2tog; rep from * to 1 st before m, k1, yo, k2] 3 times, yo, k1, ******yo, k2tog; rep from ****** to last 7 sts, k1, yo, k6—184 sts each large section; 748 sts total.

Row 164: K6, [yo, k184, yo, k2] 3 times, yo, k184, yo, k6—186 sts each large section; 756 sts total.

Border: Knit 12 rows. BO all sts very loosely. Weave in loose ends. Block. ∞

Cheryl Oberle, owner of Cheryl Oberle Designs, has been teaching shawl knitting for the past decade. She lives in Denver, Colorado, where she is working on a compilation of shawl designs from the world over. Look for Folk Shawls from Interweave Press in the spring of 2000.

EVERYTHING YOU NEED FOR YOUR NEEDLEWORK PROJECTS

(and maybe some things you didn't even know you needed!)

We stock over 1,000 different yarns in a huge array of colors including:

- Ad hoc
- Alice Stormore
- Annabelle Fox
- Berroco
- Brown Sheep
- Cherry Tree Hill
- Classic Elite
- Colinette
- Collezione S. Charles
- Dale of Norway
- Filatura di Crossa
- GGH
- Gedifra
- Harrisville
- Jaeger
- Jo Sharp
- Katia
- Lang
- Mountain Co.
- Muench
- Noro
- Patons
- Plymouth
- Prism
- Rowen
- Sidar
- Tahki
- Vittadini

To Order: 1-800-306-7733

PERSONAL THREADS
BOUTIQUE

Knitting • Weaving • Spinning • Needlepoint

8025 West Dodge Road • Omaha, Nebraska 68114 • Fax: 402-391-0039
e-mail: carolyn@personalthreads.com • web: www.personalthreads.com

For a free newsletter/catalog send a card with name, address, phone and your interests.

Sealed With A Kiss

Sweater Art Designs by Keely

Christmas Cookies



Pattern \$10.50
(+\$2.50 S&H)
Kit \$90.00
(+\$6.50 S&H)

Black, Green, Maroon,
Celadon or Tan
background available

Over 140 intarsia designs available, including Holidays, Professions, State Pride, International, and Kids too.



24 African inspired designs available!

Pattern \$15.95
(+\$2.50 S&H)
Kit Set \$140.00
Pullover \$102.00
Vest \$60.50 (+\$6.50 S&H for all kits)



Intarsia

A Workshop for Hand & Machine Knitting
The Most Comprehensive Source Available for Intarsia Knitting Instruction!

Tips & techniques for flawless intarsia knitting, including avoiding distorted stitches, combining fair isle and intarsia, finishing tails and much more! Instructions are included for a sampler incorporating the techniques outlined in the book.
\$15.95 (plus \$3.00 S&H)

All kits include **Tahki Cotton Classic** & pattern with the sweater graphed on easy-to-read symbolized charts.

Visa/MC/Amex/
Discover accepted

Wholesale Inquires
Welcome

S.W.A.K.
2022 W. Noble
Guthrie, OK 73044
(405) 282-8649
swak@swakknit.com

Send \$3 for
color catalog

Visit our web site at
www.swakknit.com

MOUNTAIN COLORS

HAND-PAINTED YARNS



Our smooth mohair/wool blend
(55% mohair/45% wool) with a beautiful
lustre that makes the colors sparkle!

Spun from domestic Angora goat fiber.
Try it with some of our new for '99 designs!
Ask about our textured mohair yarns.

Call for a dealer nearest you (406) 777-3377
Fax (406) 777-7313



BAVARIAN TWISTED-STITCH CARDIGAN

MEG SWANSEN

Preview pattern from
Meg Swansen's Knitting

FINISHED SIZE 44" (112 cm) chest/
bust circumference.

YARN Schoolhouse Press Filiature
Lemieux Québécoise wool (100%
wool; 210 yd [192 m]/100 g): #74
medium grey, 10 skeins.

NEEDLES Size 6 (4 mm): 24" (60-
cm) and 40" (80-cm) circular.
Adjust needle size to obtain the
correct gauge.

NOTIONS Markers (m); stitch
holders; cable needle (cn), optional;
blunt-end tapestry needle.

GAUGE 22 sts and 26 rows = 4"
(10 cm) in twisted-stitch pattern
after blocking.

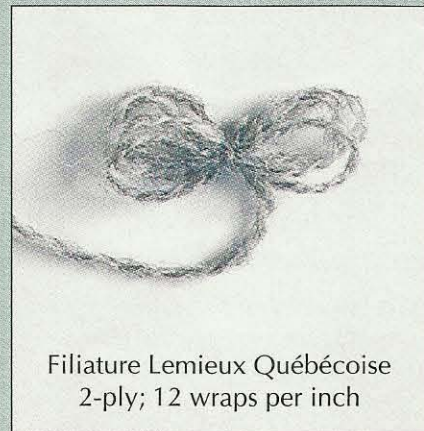

Filiature Lemieux Québécoise
2-ply; 12 wraps per inch

THIS JACKET has deeply inset (kangaroo pouch) armholes and is worked in the round from lower edge upward. The armholes and center front are stitched and cut, and the saddle is worked from the center neck back to each cuff. The firmly-spun wool helps achieve the carved-in-wool sculpted effect of this type of texture knitting.

These numbers are for the garment I knitted. I trust that if you are experienced enough to launch into this type of texture knitting, you will also know how to alter the numbers to fit your gauge and measurements. (Here is where a "bird's-eye-view" [see page 46] is useful to redesign a garment; figure total number of stitches for the circumference you want, place the large motifs around the oval, add up the number of stitches they take, then fill in between them with purl, twisted knit, and perhaps two-stitch cables to get to the desired number of stitches.)

When knitting cables and twisted stitches, I automatically mirror-image the patterns on either side of the center of a piece—I just read the same stitch chart backwards.

A generous swatch is essential; not only to practice the texture patterns, but to determine the gauge after blocking. When the swatch is wet, you may stretch it horizontally quite severely—practically flattening the pattern; or you may prefer to have the welts stand up more prominently to yield an entirely different gauge. Block the swatch to please you, let it dry, then read the gauge.

The cable charts are taken from the trilogy of books by Maria Erlbacher, *Überlieferte Strickmuster*. The books are published by the museum of the Castle of Trautenfels, which is tucked away in a remote and romantic section of the Austrian Alps. The charts are traditional and authentic patterns of this region of Austria.

Stitches

These twisted-stitch patterns can be worked with a cable needle as described with the charts on page 46, or without a cable needle as described here. Every time I say "knit" it is understood that I mean "knit into the back of the stitch."

Right twist knit over purl:

Transfer two stitches to right needle. With left needle, grab the purl stitch from behind and slide both stitches off right nee-

dle, letting the knit stitch fall free for a moment. Pick up the knit stitch and put it onto left needle and knit the first stitch, then purl the second. This technique becomes surprisingly smooth to execute after a bit of practice, and causes the least amount of stitch distortion.

Right twist knit over knit:

Work as described above, substituting a knit stitch for the purl stitch.

Left twist knit over purl:

Transfer two stitches to right needle. With left needle, grab the knit stitch from in front and slide both stitches off right needle, letting the purl stitch fall free for a moment. Pick up the purl stitch from behind (and *under* working wool) with right needle, place on left needle and work.

Left twist knit over knit:

Work as described above, substituting a knit stitch for the purl stitch.

• **Body:** CO 220 sts + 7 steek sts. Join, being careful not to twist sts. On next row, beg patts as charted. Note: Each motif is originally separated by a p2, k2b, p2 "filler". I eliminated the need for a lower edge treatment by sneakily increasing 1 st into each purl section except at center front after about 3½" (9 cm). Thus I achieved my desired body circumference (248 sts + 7) and had an organic, natural born (as Pogo would say) ribbing. Work in patt until piece measures 18" (46 cm). **V-neck shaping:** Dec 1 st each side of center 7 steek sts as follows: *Knit the steek sts, ssk, knit around to within 2 sts of steek, k2tog. Knit 3 rnds plain. Rep from * 18 times total, and *at the same time*, **shape kangaroo pouch armholes:** Place 30 sts on holders at each underarm, centered above "seam" st on each side. CO 7 steek st in their place, and cont around, maintaining V-neck shaping at center front. When armholes measure 7" (18 cm), place all sts on a holder. **Cut steeks:** Baste down the centers of the 3 steeks. Machine stitch (using small stitches and loose tension) down the left side of the center steek st and up the right side of the same st. Cut open just one armhole and the V-neck. Don't cut all the way to the bottom of the body as it is easier to knit the sleeves without the body flapping about.

• **Right Yoke/Sleeve (wearer's right):** At center back, use the provisional method (see Glossary, page 7) to CO 10 sts. Work

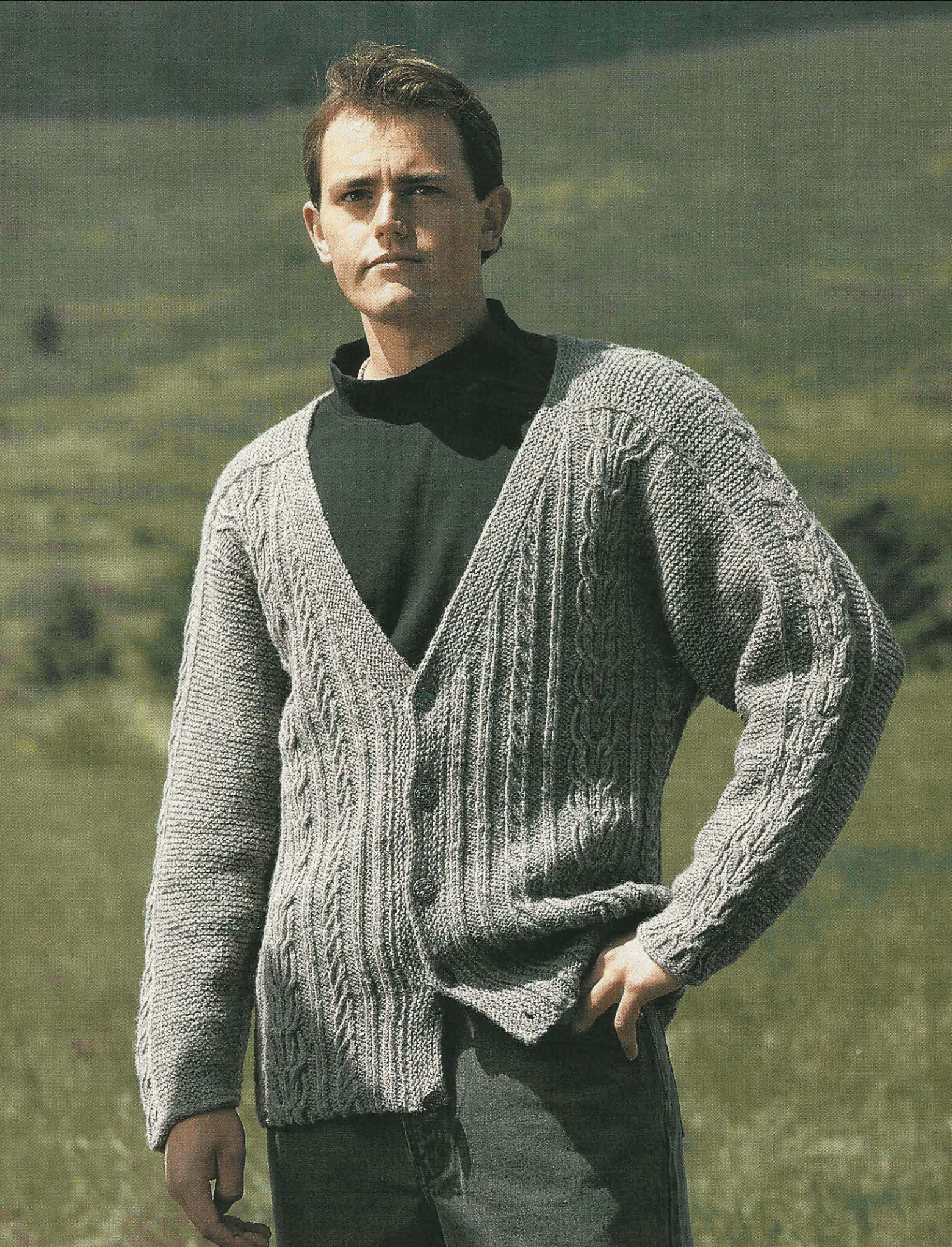

 place 4 sts on cn to back; k1 tbl, p2, k1 tbl, then k1 tbl, p2, k1 tbl on cn

 place 4 sts on cn to front; k1 tbl, p2, k1 tbl, then k1 tbl, p2, k1 tbl on cn

 1/1RCP: place 1 st on cn to back; k1 tbl, p1 on cn

 1/1LCP: place 1 st on cn to front; p1, k1 tbl on cn

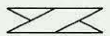
 2/2RC: place 2 sts on cn to back; k2 tbl, k2 tbl on cn

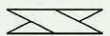
 2/2LC: place 2 sts on cn to front; k2 tbl, k2 tbl on cn

 1/1RC: place 1 st on cn to back; k1 tbl, k1 tbl on cn

 1/1LC: place 1 st on cn to front; k1 tbl, k1 tbl on cn

 p on RS; k on WS

 k tbl on RS

Bird's-Eye View

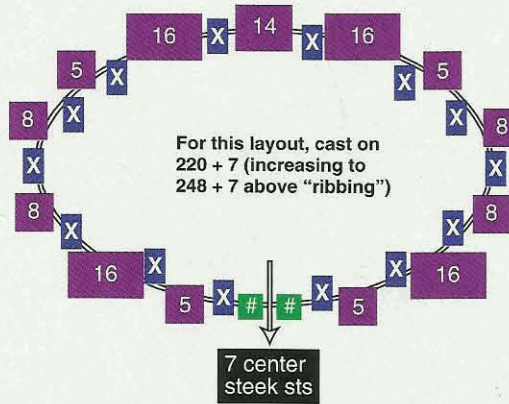

5 = pattern #105
 8 = pattern #54
 16 = pattern #155
 14 = pattern #15
 X = (p2, k2b, p2) inc to (p3, k2b, p3) above the "ribbing"
 # = p1, k2b (from center out) plus 7 steek sts at center front

The numbers in boxes indicate number of sts in patt rep.

#15

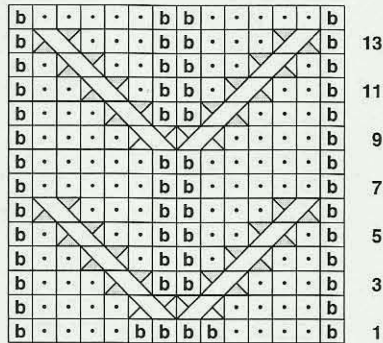

#155

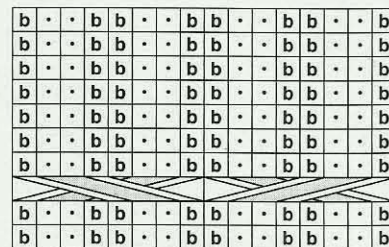

Center Front

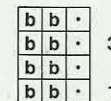

X Filler



#105

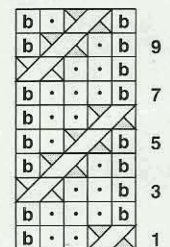

#54

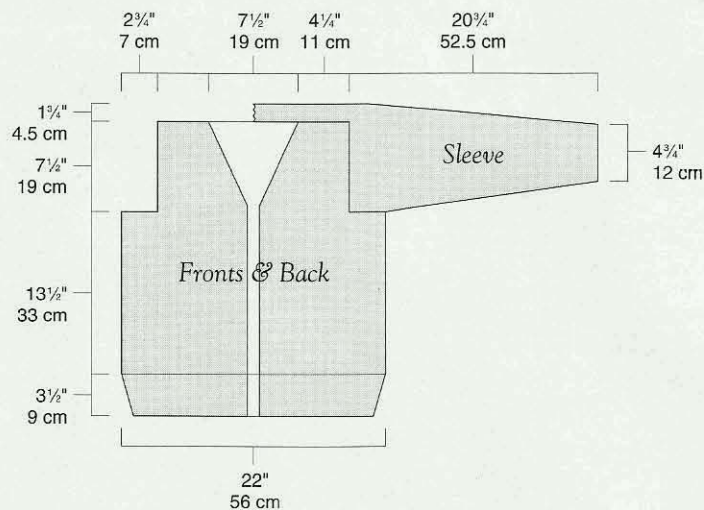
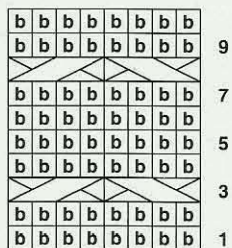

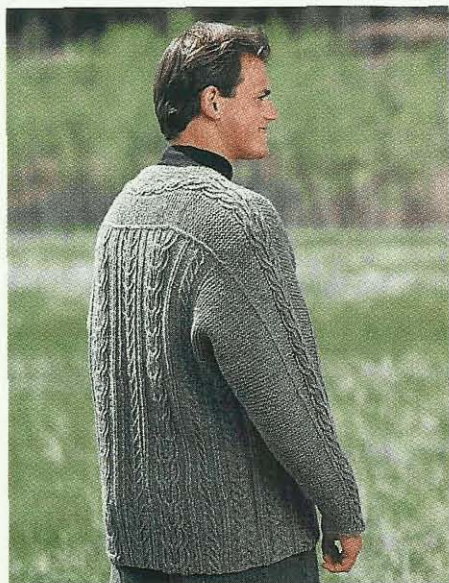

back and forth in garter st (perpendicular to the body), joining the last st of every other row to the raw body sts as follows: *K9, yarn fwd, sl 2 sts pwise (the last yoke st and 1 raw body st), turn, k2tog; rep from * until you are even with the front neck edge, then using provisional CO 13 more sts—23 CO sts total. Mark the center of these sts. See how the neck back is lowered slightly? Cont to join sts on the back as established, but on the front, work to last st, ssk (last yoke st and 1 raw front body st), turn, yarn fwd, sl 1 st pwise. These two methods of joining sts will be reversed when you work the left half of the saddle sleeve to produce a handsome, matching St-st line at each of the four joins, so stay alert.

When you reach the armhole edge, pick up 2 sts for every 3 rnds on cut armhole selvages and all the raw sts at underarm. Now knit back and forth on all vertical sleeve sts, joining the end st of each row to a raw kangaroo-pouch st as you did on the shoulders, until all pouch sts are gone. And *at the same time*, beg dec at center top of sleeve when you reach the armhole edge. Mark the 12th st and from the “right” side, *k2tog, knit marked st, ssk. Knit 6 ridges (12 rows) plain. Rep from * every 7th ridge about 4 or 5 times. Work straight to just above elbow length and switch the dec to the underarm, 1 or 2 sts in from each selvage every 5th or 6th ridge, or even faster (depending on desired circumference at cuff and length in which to get there; I worked to 20" [51 cm] from inset armhole to cuff and ended up with

39 sts). Work 2-st I-cord cast-off (see illustrations) as follows: On left needle, CO 2 cord sts. *K1, k2tog tbl (last cord st and 1 st-to-be-cast-off), replace 2 sts to left needle; rep from * around cuff. The cuff I-cord may be cont to unite the sleeve seam as foll: Do not break the wool. Pick up 1 st for each ridge along the sleeve selvage; a separate needle on either side. Hold them parallel. Knit the 2 cord st and replace onto back parallel needle. *K1, sl 1, k2tog (1 from each parallel needle), pssso. Replace 2 sts to back needle. Rep from *.

•**Left Yoke/Sleeve:** Pick up the 10 sts from the provisional CO at center back neck, and work as for right yoke/sleeve, remembering to reverse the method of joining the yoke to the raw body sts. As you read this, it may seem complicated, but when you are there, you will be able to *read* your knitting and it should all make sense.

I ran cable #155 (see chart) down the tops of the sleeves, decreasing each side of the cable (starting with the left half of the cable going toward the left sleeve and the right half of the cable going toward the right sleeve). I fussed about the relationship of the garter-stitch sleeve to the cable. Although I did not come up with an actual formula, I found it necessary to work a short-row each side of the cable every 10 rows (5th ridge) as follows: *Knit to cable, wrap, turn, knit back*. Knit across all sts and rep from * to * on other side of cable. Since the cable is a 10-row rep, it is easy to remember to insert the short rows every time you twist the cable. Without these inserted ridges, the cable bulged. You may decide to eliminate both the cable *and* the fuss and work plain sleeves.

•**Finishing:** Cut the center front open bet the machine stitching. Beg at lower left side, pick up and knit 2 sts for every 3 rnds to the V-neck. Pick up and knit 4 sts for every 5 rnds on the diagonal slope. Remove waste yarn from the provisional CO at front neck edge, you may (or may not!) now need to rip back 1 row of the yoke to keep the continuity of garter st as you knit across the yoke. Pick up and knit 1 st for each ridge across the back neck, and mirror image down the right side. Turn. Knit back and forth for 6 to 8 ridges, adding your favorite buttonholes on the appropriate side after 3 or 4 ridges. Work I-cord cast-off as before. ∞

2-Stitch I-Cord Cast-Off



Make two backward loops (cord stitches) on the end of the left needle, which holds the stitches to be cast off. *Knit one stitch, knit the last cord stitch together with the stitch to be cast off through their back loops (figures 1 and 2), replace these two stitches onto the left needle (figure 3), and repeat from *.

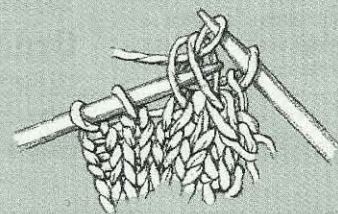

figure 1

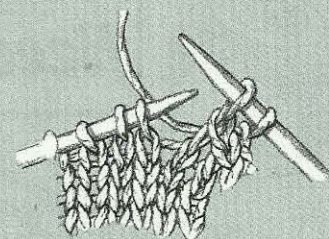

figure 2

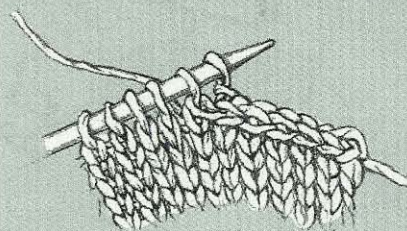

figure 3

Meg Swansen, owner of Schoolhouse Press, has been knitting since childhood. Look for her newest book, *Meg Swansen's Knitting*, from Interweave Press this fall. A how-to video for this sweater, “Saddle-Sleeve Jacket,” is available from Schoolhouse Press.

The World's Largest Selection of Knitting Supplies

Where to Get the Yarn

THE BUTTONS, THE BOOKS, & THE TOOLS

Aztec Daisy Cardigan •
Estonian-Inspired Pocket
Bag • Maghrib Vests •
The Sanquhar • Medallion
Kimono Jacket • Ute Socks
• Petroglyph • Andhra
Pradesh Vest

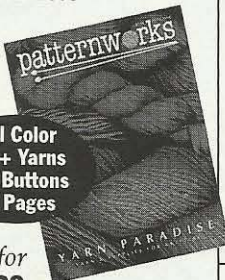

Full Color
150+ Yarns
800 Buttons
92 Pages

Ask for
our 20th
Anniversary Special
Yarn Paradise sent 1st class
mail with the indispensable
plastic cards, The Yarn
Yardage Guide & Knitter's
Reference only \$3ppd.

Software for Knitters

to use with Windows™



The Sweater Wizard® lets you
quickly produce a customized
sweater pattern (flat or circular). Centers patterns.



Stitch & Motif Maker® is the
first paint program for knitters.
Each program \$89.95. Both for \$159.

Visit www.knittingsoftware.com

Organized Expressions™ A Notebook & Diary

is the first database designed for knitters.

Includes a complete yarn listing so it's
also a yarn interchange guide.

D-200 Organized Expressions \$24.95



patternworks

Where your satisfaction is absolutely guaranteed

Orderline: 1-800-438-5464

PO Box 1690, Dept. IKF99, Poughkeepsie, NY 12601

Visit us in person at our Yarn Paradise or on the web at www.patternworks.com



Need Special Tools?

From the basics to the
downright bizarre, we
have all the needles,
yarns, patterns, books,
videos and accessories
you need for knitting.

We carry supplies for all
types of needlework!

The Needlepoint Joint

241 Historic 25th Street, Ogden, UT 84401

We have an amazingly eclectic stock—
Call 1-801-394-4355 for our free annual catalog!
<http://www.needlepointjoint.com>

275 and Counting!

That's how many Knitting
Books we distribute—from
the classics to the newest
best-sellers.

Many yarn and specialty stores across
the country stock our books. Check
with your local store or send \$3.00 for
a copy of our catalog to:

UNICORN BOOKS AND CRAFTS, INC.

1338 Ross Street
Petaluma, California 94954-1117

Phone: 707-762-3362

Fax: 707-762-0335

2 NEW Knitting Pattern Books by Betty Lampen

"Knitted
Teddy Bears
& Dolls"



"Best Dressed
Teddy Bears"
Book 3
of "Sweaters for
Teddy Bears"

Betty Lampen, Dept IK

2930 Jackson St.

San Francisco, CA 94115-1007
Books \$7 each—postage included
CA residents include tax. US funds only.
<http://www.bettylampenknitbooks.com>

BESTSELLERS FROM INTERWEAVE PRESS



The Knitter's Companion

Vicki Square

- ◆ Illustrated instructions for a wide range of knitting techniques, plus buttonholes, seams and hems, body measurements, yarn estimates, conversions
- ◆ Fits in your tote bag, stays open while you knit

7 × 5, spiralbound, 112 pages, b&w technique illustrations. #671—\$17.95 + s&h

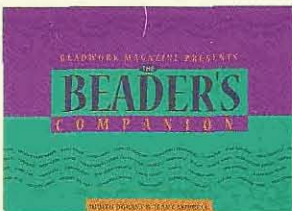

The Beader's Companion

Judith Durant and Jean Campbell

- ◆ Covers types and sizes of beads, thread and cord, needles, off-loom stitches, loom and embroidery techniques, findings, wirework, finishings, macramé
- ◆ Fits in your beadbox, stays open while you work

7 × 5, spiralbound, 104 pages, 100 technique illustrations. #1011—\$19.95 + s&h



Slip-Stitch Knitting Color Pattern the Easy Way

Roxana Bartlett

- ◆ Intricate multicolored patterns without having to carry two yarns
- ◆ Instructions for 13 original garments

8½ × 9, paperbound, 96 pages, 36 color photos. #683—\$21.95 + s&h

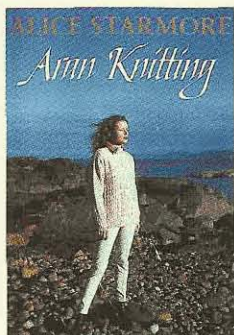

Aran Knitting

Alice Starmore

- ◆ Complete Alice Starmore workshop
- ◆ 60 charted patterns and 14 original Alice Starmore garments

8½ × 12, hardbound, 176 pages, color photos. #723—\$39.95 + s&h

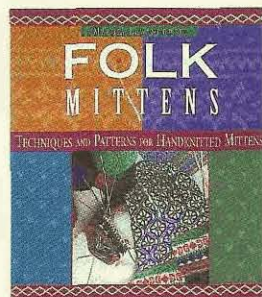

Folk Mittens

Marcia Lewandowski

- ◆ 38 patterns from around the world, each with full-color graph
- ◆ Technical coverage for gauge, washing and felting, casting on, cuffs, thumbs

8½ × 9, paperbound, 120 pages, 38 charts and patterns. #694—\$18.95 + s&h

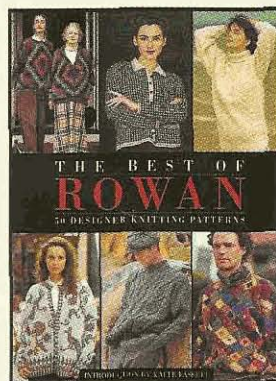

The Best of Rowan

50 Designer Knitting Patterns
Introduction by Kaffe Fassett

- ◆ 50 stunning garments from Rowan designers, including Kaffe Fassett, Annabel Fox, Amanda Griffiths, Kim Hargreaves
- ◆ Line-by-line instructions and charts
- ◆ Expert technical advice

9 × 12, hardbound, 192 pages, 60 color photos. #1012—\$35.00 + s&h

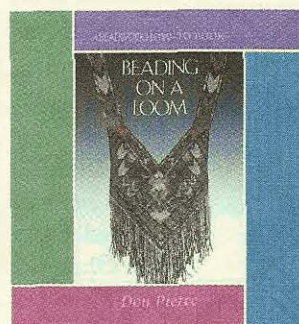

Beading on a Loom

A Beadwork How-to Book
Don Pierce

- ◆ Loom construction
- ◆ Warping
- ◆ Basic Weaving
- ◆ Increasing and Decreasing
- ◆ Weaving Triangles
- ◆ Finishing
- ◆ Correcting Mistakes
- ◆ Plus graphing designs, blending colors, and using negative space

8½ × 9, softbound, 112 pages, 75 color photos. #1018—\$21.95 + s&h

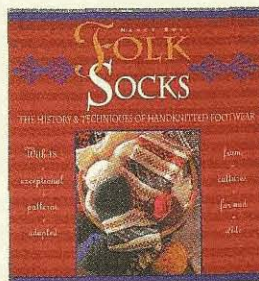

Folk Socks

The History and Techniques of Handknitted Footwear

Nancy Bush

- ◆ 18 great sock patterns from a host of folk knitting traditions
- ◆ Technical coverage for heel turnings, toe shapings, and top ribbings

8½ × 9, paperbound, 120 pages, color and b&w photos. #654—\$16.95 + s&h



Also Available:

800-645-3675.

The Lacy Knitting of Mary Schiffmann

Nancy Nehring
#776—\$17.95 + s&h

Lace from the Attic A Victorian Notebook of Knitted Lace Patterns

Nancie Wiseman
#775—\$17.95 + s&h

Traditional Knitted Lace Shawls, Revised Edition

Martha Waterman
#911—\$21.95 + s&h

Gossamer Webs The History and Techniques of Orenburg Lace Shawls

Galina Kbmoleva and Carol R. Noble
#774—\$21.95 + s&h

Find these books at your favorite craft source or call Dept. A-K1 at **800-645-3675.**

Interweave Press 201 E. Fourth St. Loveland, CO 80537-5655 www.interweave.com



MEDALLION KIMONO JACKET

NORIKO SEKIGUCHI

Worked in one piece

Intarsia patterning

FINISHED SIZE 38½ (44½, 48)"
(98 [113, 122] cm) bust/chest
circumference, buttoned. Jacket
shown measures 38½" (98 cm).

YARN Alice Starmore Scottish Cam-
pion (100% wool; 150 yd [137 m]/
1 oz): #599 loganberry (MC), 6 (7,
7) skeins; #1300 aubretia (CC1), 5
(6, 6) skeins; #700 royal blue (CC2),
2 (3, 3) skeins.

NEEDLES Size 2 (2.5 mm): 29" (80-
cm) and 40" (100-cm) circular (cir).
Adjust needle size if necessary to
obtain the correct gauge.

NOTIONS Markers (m); bobbins;
tapestry needle; size D/3 (3-mm)
crochet hook; four ⅜" (1-cm)
buttons.

GAUGE 30 sts and 37 rows = 4"
(10 cm) in St st and color pattern.

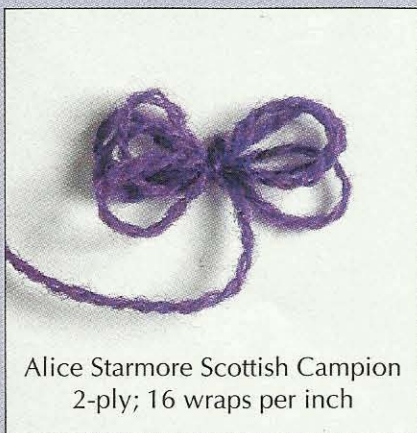

Alice Starmore Scottish Champion
2-ply; 16 wraps per inch

THE MOTIFS AND COLORS
of traditional Japanese kimonos
inspired this jacket. The entire
garment is knitted as one piece so that
only minimum seaming is required. Light-
weight yarn makes it perfect for early fall
days and indoor wear.

The fronts are worked separately to the
shoulders, including sleeves and neck shap-
ing. Then the left front is worked to the
neck opening, stitches are cast on for the
back neck, and the right front (and sleeve)
are worked onto the same needle. When
the sleeves are completed, the back is
worked downward to the waist. To facili-
tate seaming, work a selvedge stitch at
each edge of the body and collar. (These
stitches are not included in finished
measurements.)

Note: The front bands are worked along
with the body and later folded over for dou-
ble thickness. Flower motifs at the bottom
of the fronts and back and the ones worked
in the main color along the underarm are
omitted for size large. Use the M1 method
(see Glossary, page 9) to increase a single
stitch; use the cable method (see Glossary,
page 7) to increase two or more stitches.

Stitch

Bramble Stitch: (mult of 4 sts)

Rows 1 and 3: (RS) Purl.

Row 2: *(K1, p1, k1) in same st, p3tog; rep
from *.

Row 4: *P3tog, (k1, p1, k1) in same st; rep
from *.

Rep Rows 1–4 for patt.

•**Left Front:** With shorter needle and MC,
CO 82 (91, 97) sts. Do not join. Beg with
a RS row, work garter st (knit every row)
for 4 rows. The first and last sts are edge sts
and will be worked into the seam. Place m
12 sts before end of row to mark button-
band foldline. Beg chart as indicated for
your size (omitting partial floral motifs on
sizes small and medium). Work 30 rows of
red-boxed patt rep 3 (2, 2) times, then work
to row indicated for your size, placing m on
center front st on last row. Cont as estab-
lished until piece measures about 10 (10¾,
12¼)" (25.5 [27.5, 31] cm) from beg, end-
ing with Row 30 (26, 22). **Shape sleeve
and neck:** Cont in patt, at the beg of RS
rows, inc 2 sts 2 times, 3 sts 2 (1, 1) time(s),
4 sts 4 (1, 1) time(s), 3 sts 19 (25, 26) times,
4 sts 1 time, and 5 sts 2 (2, 1) time(s). Then
CO 24 sts—121 (124, 122) sleeve sts inc'd.
At the same time, when piece measures

about 12 (12¾, 14¼)" (30.5 [32, 37.5] cm)
from beg, ending with Row 19 (15, 15) of
chart, shape neck as foll: (WS) BO 23 sts
(at neck edge), work to end. Then dec 1 st
at neck edge every other row 1 (5, 5)
time(s), then every 4 rows 16 (15, 15)
times—163 (172, 176) sts rem. Cont in
patt until piece measures about 26½ (27½,
29¾)" (67.5 [70, 75.5] cm) from beg, end-
ing with Row 14 of chart. Place all sts onto
longer cir needle. Mark placement of 4
buttons, one 1¼" (4.5 cm) from lower edge,
one ½" (1.3 cm) from neck edge, and the
others evenly spaced in between.

•**Right Front:** Work as for left front,
reversing all shaping and placing m for
front band foldline. At the same time, work
double-faced vertical buttonholes (adapted
from Dorothy Ratigan's "Beyond the
Basics," *Interweave Knits*, Spring 1997)
opposite markers as follows: *With WS
facing, and beg 2 rows before button m,
[work to 19th st counting from the last st
(18 sts rem), join new yarn, work 12 sts,
join second new yarn, work to end of row,
turn. Work to the buttonhole opening,
cross the first 2 yarns, work 12 sts, cross the
second 2 yarns, work to end of row with
other yarn, turn. Work to buttonhole
opening, drop yarn, pick up other yarn
without crossing yarn ends, work 12 sts,
drop yarn, pick up other yarn without
crossing yarn ends, work to end of row] 2
times. Work 2 more rows, crossing yarns
at opening and end with a RS row. Cut
new yarns. With WS facing, work to end
of row and cont in patt to 2 rows before
bottom of next marked button placement.
Rep from * for each buttonhole.

•**Back:** Cont in patt (Row 15 of chart),
work left front sts from arm to neck edge,
cable CO 45 (51, 51) sts for back neck,
work right front sts from neck to arm
edge—371 (395, 403) sts. Cont in patt for
45 (45, 49) rows, ending with Row 30
(30, 4) of chart (WS)—sleeve cuff should
measure about 10 (10, 10½)" (25.5 [25.5,
26.5] cm). BO 24 sts at beg of next 2 rows.
At beg of next 2 rows, BO 5 sts 2 (2, 1)
time(s), 4 sts 1 time, 3 sts 18 (25, 26)
times, 4 sts 5 (1, 1) time(s), 3 sts 2 (1, 1)
time(s), 2 sts 2 times—127 (147, 159) sts
rem. Cont in patt until piece measures
about 21¼ (22½, 24½)" (54 [57, 62] cm)
from back neck, ending with same row of
chart that fronts were begun on. With MC
only, work garter st for 4 rows (purl all 4
rows). BO all sts pwis.

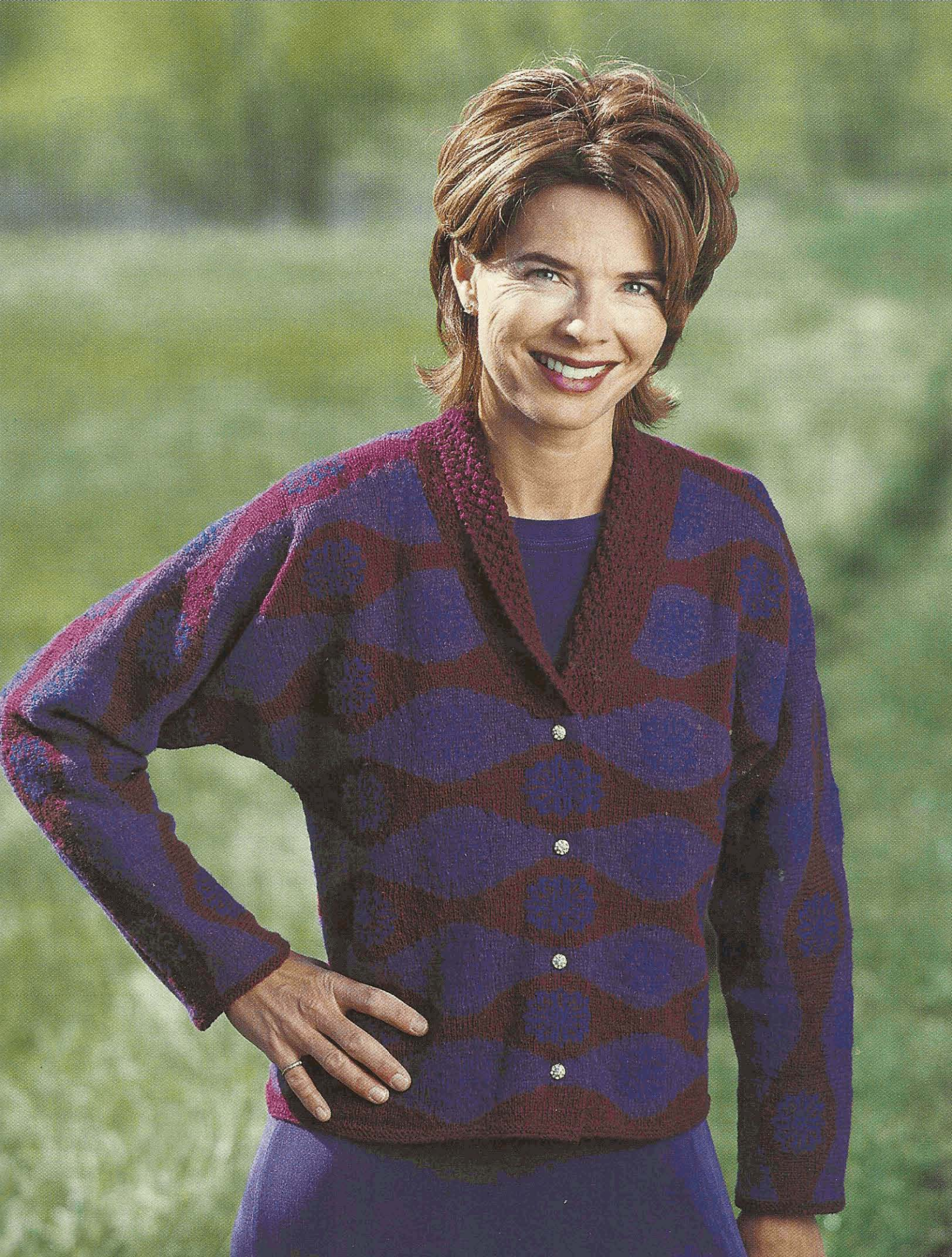

•**Finishing:** Block. Fold front bands on indicated folding lines to WS and use yarn threaded on a tapestry needle to sew in place. **Collar:** With MC, CO 14 sts (the first and last sts are edge sts). Note: Maintaining edge sts at each side, do not work a bramble unless there are enough sts to do so; work extra inc sts in St st. Work bramble st, knit 2 rows. At the beg of needle every RS row, inc 2 sts 2 (3, 3) times, 1 st 10 (12, 12) times, then inc 1 st every 4 rows 6 times, then inc 1 st every 6 rows 4 times

(end with RS row)—38 (42, 42) sts. Work bramble st for 63 rows. At the beg of needle dec 1 st, then dec 1 st every 6 rows 4 times, every 4 rows 6 times, every other row 9 (11, 11) times, then dec 2 sts every other row 2 (3, 3) times—14 sts rem. Work 1 row even. BO all sts. Mark center st of collar. With WS of body facing, match the marked st of collar to center of back neck. With MC threaded on a tapestry needle, sew collar into neck opening of body and sew top of front bands and bottom of

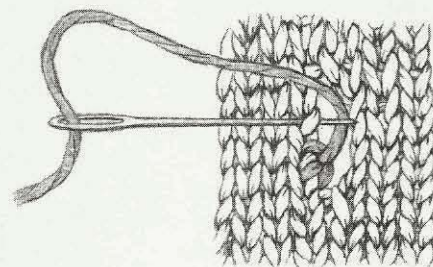

Buttonhole stitch

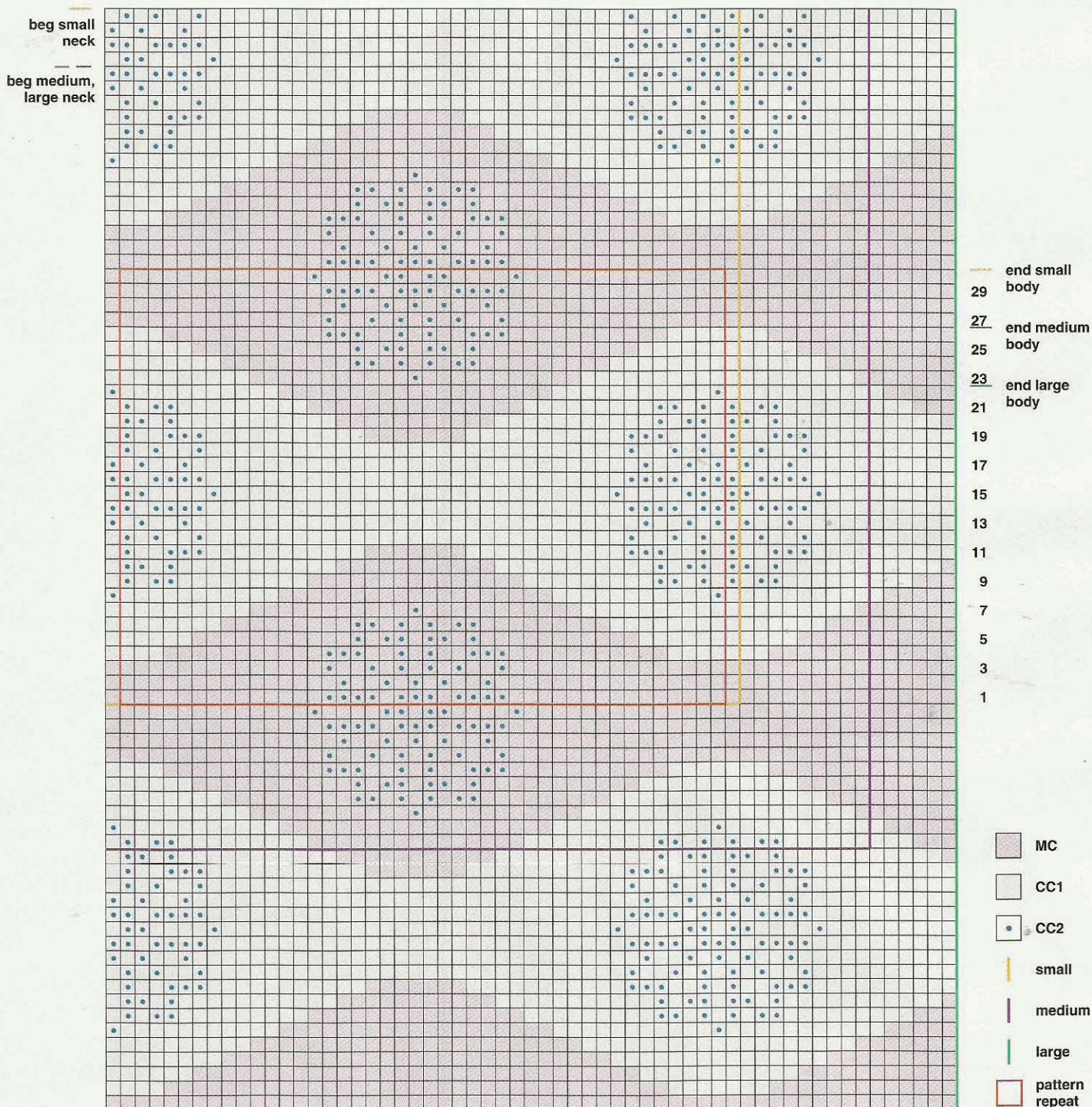

collar tog. **Sleeve edging:** With MC and RS facing, pick up and knit 66 (66, 70) sts around sleeve edge. Work garter st for 4 rows. BO all sts. With yarn threaded on a tapestry needle, sew side and sleeve seams. With background-color yarn threaded on a tapestry needle, work buttonhole st around buttonholes, sewing upper and lower holes tog. Sew buttons to buttonband. With RS facing, work rev sc (see Glossary, page 8) relatively loosely around outer edge of collar as a trimming. Weave in loose ends. ∞

For Noriko Sekiguchi, knitting was a relaxing solo activity until she recently discovered the fun of group knitting. She now gathers once a month with the Kings County Knotty Knitters in Brooklyn, New York, to share projects, ideas, and her passion for knitting. The good food, conversation, and friendship inspire her to explore new design ideas.

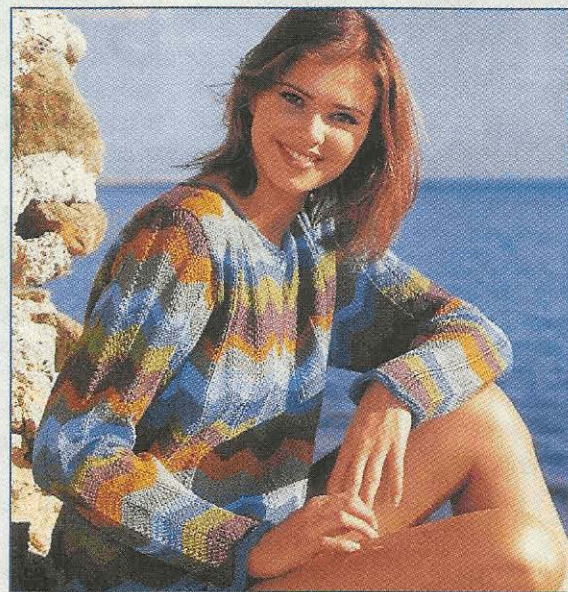
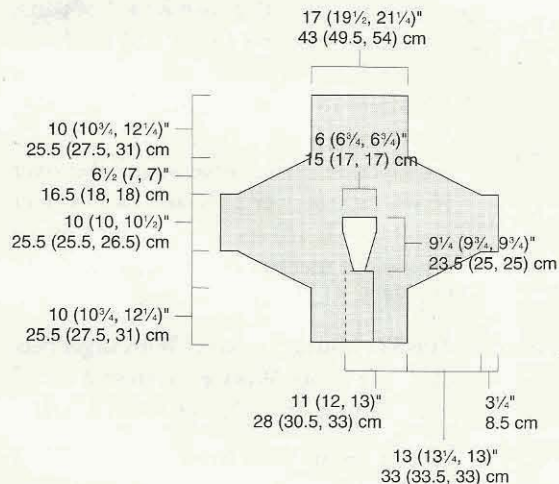

GARNSTUDIO yarns and **DROPS Design** Scandinavia's most exciting yarns & patterns now available throughout North America!

For dealer information, please contact:

AURORA YARNS

P.O. Box 3068 Moss Beach CA 94038 USA tel: 650-728-2730 fax: 650-728-8539 aurorayarns@pacbell.net	P.O. Box 28553 Aurora, ONT, L4G 6S6 Canada tel: 877-494-9276 fax: 905-841-1218 aurorayarns@sympatico.ca
---	---



LAMBSPUN

Experience
Knitters
Swatch Club™

\$15.00/year-Six Issues... include

*Five Exciting Yarns to Swatch • Newsletter
Original & Exclusive Patterns • Huge Savings!
and More!*

Let Lambspun spark your creativity...



Summit Silks

Join Now!!

By phone or mail...
Visa/MC accepted!

Lambspun of Colorado
1-800-558-5262

1101 E. Lincoln Ave., Dept. K • Fort Collins, CO 80524
www.lambspun.com

Swatch Club™
∞ for Discerning Knitters ∞



YARNS INTERNATIONAL
presents
Chesapeake Collection
Nine Original Ron Schweitzer
Knitwear Designs in Pure Shetland Wool

The sweaters in the *Chesapeake Collection* are knit from Shetland 2000™, 100% pure Shetland wool, unaltered by processing or dyes. The yarn's natural softness makes it pleasant to work with and extremely comfortable to wear.
\$14.95 plus shipping.

Also available: *Travel Logs*, our premier Fair Isle collection of nine original designs by Ron Schweitzer.
\$12.95 plus shipping.

New from Jade Starmore A Collectors Item.
\$33/hardcover; \$24/softcover, plus shipping.

For brochures, color cards and pattern books contact us:
5110 Ridgefield Rd, Suite 200, Bethesda, MD 20816
telephone: (301) 913-2980 • fax: (301) 913-0381
www.yarnsinternational.com
e-mail: info@yarnsinternational.com



To Order: 1-800 YARNS 2U
(1-800-927-6728)

Photo: Annie Asher/Annie



ARAN DUFFLE COAT

JUDITH L. SWARTZ

Heavily textured

Pockets and hood

FINISHED SIZE 41 (44½, 48, 51½)" (104 [113, 122, 131] cm) bust/chest circumference, buttoned. Jacket shown measures 48" (122 cm).

YARN Plymouth Manukau Wools Sierra Lana Chunky (100% wool; 262 yd [240 m]/200 g): #312 fawn, 7 (7, 8, 8) skeins.

NEEDLES Body and Sleeves—Size 9 (5.5 mm): straight and 32" (80-cm) circular (cir); I-cord—Size 4 (3.5 mm): set of 2 double-pointed (dnp). Adjust needle sizes if necessary to obtain the correct gauge.

NOTIONS Markers (m); cable needle (cn); stitch holders; tapestry needle; three 4½" (11.5-cm) buttons, style NPL 186 from One World Buttons.

GAUGE 15 sts and 20 rows = 4" (10 cm) in St st on larger needles; 14 sts and 22 rows = 4" (10 cm) in moss st on larger needles; 18 sts and 22 rows = 4" (10 cm) in combination of patt sts on larger needles.



Plymouth Sierra Lana
2-ply; 7 wraps per inch

BASED ON a duffle shape, this oversized hooded coat features deeply cuffed sleeves, dropped shoulders with saddle details, roomy pockets, and toggle closures. The cable stitches repeat over evenly divisible row increments to make the coat relatively easy to knit, yet highly textured. This project is suitable for the intermediate knitter. It is ideal for someone new to cables because there are several to learn, but keeping count of them is relatively easy.

Abbreviations

2/1LCP: Sl 2 sts onto cn and hold in front, p1, k2 from cn.

2/1RCP: Sl 1 st onto cn and hold in back, k2, p1 from cn.

2/2LC: Sl 2 sts onto cn and hold in front, k2, k2 from cn.

2/2RC: Sl 2 sts onto cn and hold in back, k2, k2 from cn.

2/1LC: Sl 2 sts onto cn and hold in front, k1, k2 from cn.

2/1RC: Sl 1 st onto cn and hold in back, k2, k1 from cn.

Stitches

Moss Stitch: (mult of 2 sts)

Row 1: *K1, p1; rep from *.

Rows 2 and 4: Knit the knits and purl the purls.

Row 3: *P1, k1; rep from *.

Rep Rows 1–4 for patt.

Twist Stitch: (worked over 2 sts)

Row 1: K2tog but do not drop sts off needle, knit first st again, and drop both sts off needle.

Row 2: Purl.

Rep Rows 1 and 2 for patt.

Crossed Cable: (worked over 12 sts)

Row 1: (RS) P4, 2/2RC, p4.

Rows 2, 4, 6, and 8: Knit the knits and purl the purls.

Row 3: P3, 2/1RCP, 2/1LCP, p3.

Row 5: P2, 2/1RC, k2, 2/1LC, p2.

Row 7: P1, 2/1RC, k4, 2/1LC, p1.

Rep Rows 1–8 for patt.

Superimposed Double Wave Cable: (worked over 16 sts)

Row 1: (RS) K2, p3, k2, p2, k2, p3, k2.

Row 2 and all other WS rows: Knit the knits and purl the purls.

Row 3: 2/1LCP, p2, 2/1LCP, 2/1RCP, p2, 2/1RCP.

Row 5: P1, 2/1LCP, p2, 2/2LC, p2, 2/1RCP, p1.

Row 7: P2, [2/1LCP, 2/1RCP] 2 times, p2.

Row 9: P3, 2/2LC, p2, 2/2LC, p3.

Row 11: P2, [2/1RCP, 2/1LCP] 2 times, p2.

Row 13: P1, 2/1RCP, p2, 2/2LC, p2, 2/1LCP, p1.

Row 15: 2/1RCP, p2, 2/1RCP, 2/1LCP, p2, 2/1LCP.

Row 16: Rep Row 2.

Rows 17–32: Work as for Rows 1–16, except on Rows 5, 9, and 13 substitute 2/2RC for 2/2LC.

•**Back:** With larger needles, CO 92 (100, 108, 116) sts. Work k1, p1 rib for 5 rows. *Patt set-up:* (RS) Beg with Row 1 of patts, work moss st over 4 (8, 12, 16) sts, [twist st over 2 sts, superimposed double wave cable over 16 sts, twist st over 2 sts, crossed cable over 12 sts] 2 times, twist st over 2 sts, superimposed double wave cable over 16 sts, twist st over 2 sts, and moss st over rem 4 (8, 12, 16) sts. Work as established until piece measures 28 (30, 32, 32)" (71 [76, 81.5, 81.5] cm) from beg. BO all sts.

•**Pocket Lining:** (make 2) With larger needles, CO 22 sts. Work even in st st for 30 rows. Break yarn and place sts on holder.

•**Right Front:** With larger needles, CO 44 (48, 52, 56) sts. Work k1, p1 rib for 5 rows. *Patt set-up:* (RS) P2, work twist st over 2 sts, crossed cable over 12 sts, twist st over 2 sts, superimposed double wave cable over 16 sts, twist st over 2 sts, moss st over rem 8 (12, 16, 20) sts. Work in patt for 32 rows.

Join pocket linings: (RS) Work 18 sts in patt, place next 22 sts on holder, work across 22 pocket lining sts (working Row 1 of appropriate patts to align with jacket front sts), work to end in patt. Cont even until piece measures 25 (27, 29, 29)" (63.5 [68.5, 73.5, 73.5] cm) from beg, ending with a WS row. **Shape neck:** At neck edge, BO 7 (7, 8, 8) sts once, 3 (3, 4, 4) sts once, 2 (2, 2, 2) sts 2 times—30 (34, 36, 40) sts rem. Cont in patt until piece measures 28 (30, 32, 32)" (71 [76, 81.5, 81.5] cm) from beg. BO all sts.

•**Left Front:** Work as for right front, reversing pattern and pocket placement and shaping.

•**Sleeves:** With larger needles, CO 36 (38, 40, 42) sts. Work k1, p1 rib until piece measures 3½" (9 cm), ending with a WS row and inc 2 st evenly spaced on last row—38 (40, 42, 44) sts. *Patt set-up:* (RS) Work moss st over 11 (12, 13, 14) sts, twist



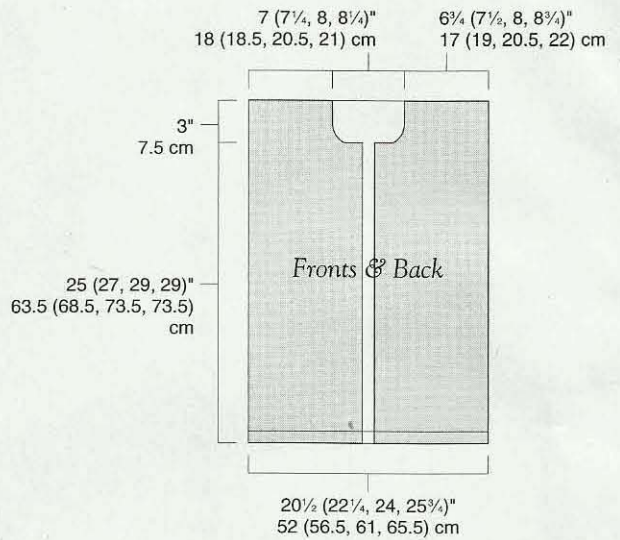
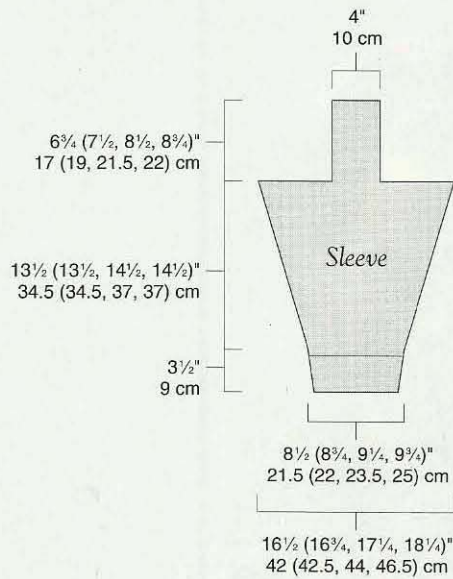
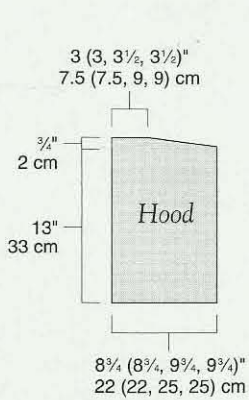

□ k on RS; p on WS □ p on RS; k on WS

⌘ twist 2: k2tog, knit first st again, drop both sts off needle

⌘ 2/1LCP: sl 2 sts onto cn and hold in front, p1, k2 on cn

⌘ 2/1RCP: sl 1 st onto cn and hold in back, k2, p1 on cn

⌘ 2/2LC: sl 2 sts onto cn and hold in front, k2, k2 on cn

⌘ 2/2RC: sl 2 sts onto cn and hold in back, k2, k2 on cn

⌘ 2/1LC: sl 2 sts onto cn and hold in front, k1, k2 on cn

⌘ 2/1RC: sl 1 st onto cn and hold in back, k2, k1 on cn

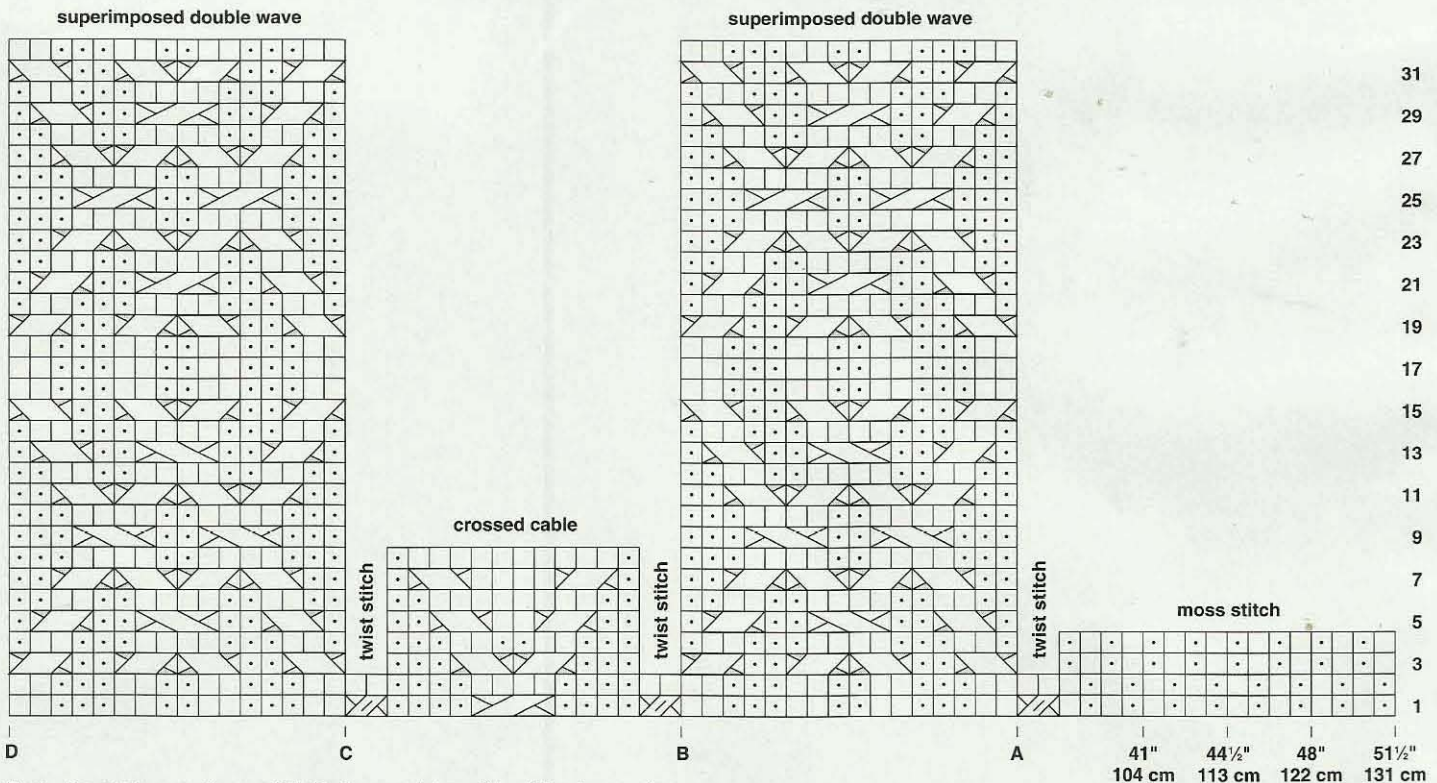
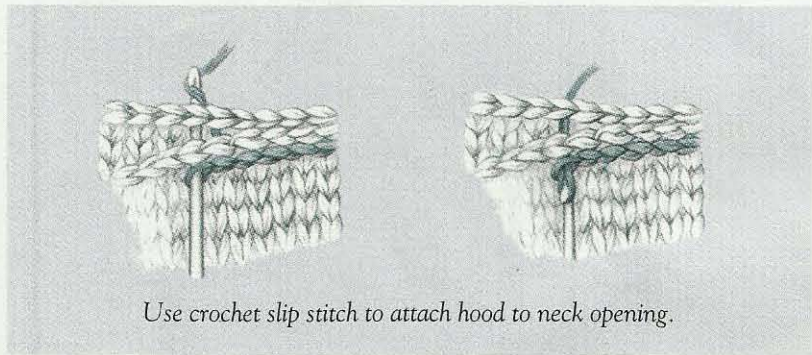

Back: Beg at chosen size; work to D; then work from C back to chosen size.

Right Front: P2, beg at B; work to D; then work from A back to chosen size.

Left Front: Beg at chosen size; work to C; p2.

Sleeve: Work moss st across 11 (12, 13, 14) sts; work B to C; work moss st across 11 (12, 13, 14) sts.

st over 2 sts, crossed cable over 12 sts, twist st over 2 sts, moss st over rem 11 (12, 13, 14) sts. Cont as established, inc 1 st each end of needle in patt every 4 rows 18 (18, 18, 19) times, working new sts in moss st—74 (76, 78, 82) sts. Cont in patt until piece measures 13½ (13½, 14½, 14½)" (34.5 [34.5, 37, 37] cm) above rib. **Shoulder extension:** BO 28 (29, 30, 32) sts at beg of next 2 rows—18 sts rem. Working 1 st at each edge in rev St st (purl RS rows; knit WS rows) and center 16 sts as established until extension measures 6¾ (7½, 8½, 8¾)" (17 [19, 21.5, 22] cm). BO all sts.

•**Hood:** With larger needles, CO 40 (40, 44, 44) sts. P2, work twist st over 2 sts, crossed cable over 12 sts, twist st over 2 sts, and moss st over rem 22 (22, 26, 26) sts. Work as established until piece measures 13" (33 cm) from beg, ending with a RS row. **Next row:** (WS) BO 13 (13, 14, 14) sts, work to end. Work 1 row even in established patts. Rep last 2 rows once—14 (14, 16, 16) sts rem. BO all sts. Make another half hood, reversing shaping.

•**Finishing:** Block all pieces. With yarn threaded on a tapestry needle sew hood

seam. With cir needle, pick up and knit 99 sts along front edge of hood. Work k1, p1 rib for 1½" (3.8 cm). BO all sts. Place 22 sts from front pocket holders on needles and work k1, p1 rib for 1½" (3.8 cm). BO all sts. Sew pocket linings in place. Sew shoulder edges to sleeve extensions. Sew sleeves in place. Sew side and sleeve seams, leaving 6" (15 cm) open for vents at sides. With straight needle, pick up and knit 40 sts across side slit. Knit 1 row. BO all sts. **Frontbands:** With cir needle, pick up and knit 85 (93, 99, 99) sts. Work k1, p1 rib for 1½" (3.8 cm). BO all sts. Using a crochet slipstitch (see page 56), join hood to jacket neck, easing to fit and aligning front rib edges. **Button loops:** (make 3) With dpn, CO 3 sts. Work I-cord (see Glossary, page 7) until piece measures 6½" (16.5 cm). BO all sts. Fold button loops in half and position on jacket right front as foll: Placing all cords so that loop extends about ½" (1.3 cm) beyond rib edge and ends butt up to first twist st from edge, place first cord about ½" (1.3 cm) below neck, second and third cords about 4" (10 cm) apart. Sew in place and tack base of loops tog. Sew buttons opposite loops. ∞

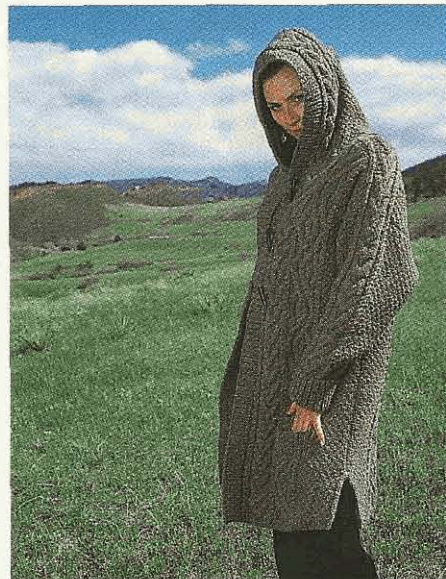

Judith L. Swartz has recently moved from Chicago to Spring Green, Wisconsin, where she looks forward to continuing her design career, beginning her marriage, and enjoying all that the future may hold.

3 TRAILS HANDKNIT DESIGNS



Simply Knit
Wonderfully Wearable

Patterns for the Handknitter



Sweaters

Vests

Socks



For dealer information and wholesale catalogs please call

816-229-2976

See our complete pattern line at www.3Trailsdesign.com

E-mail: Pamela@3Trailsdesign.com

1-800-263-8002

Call Us Toll Free during our Store Hours 10-5:30 CST
you will reach a real person...not voice mail

The Caribou Coat

100% wool
4.5mm (US 7)
One size 52"
in earthtone colours
includes pattern

Kit Price:

Cdn \$11000

US \$7500*

*approximate price
subject to current exchange rate



Exclusive
RAM WOOLS
Design



BONUS:
FREE
Exclusive
Ram
Wools
Design
pattern
in each
catalogue

CALL TOLL FREE NOW
1-800-263-8002

For our NEW FREE Full Colour
RAM WOOLS MILLENNIUM EDITION
Catalogue for Fall & Winter

CALL 1-800-263-8002
RAM WOOLS

Now moved to a larger store at 1266 Fife Street, Winnipeg, MB, Canada R2X 2N6
Email address: ram@gaspard.ca

Visit our New Secure Website: <http://www.gaspard.ca/ramwools.htm>

13

Ways to Color a Kimono

Colleen Davis

IN THE SPRING OF 1998, in Santa Fe, New Mexico, I took a sewing workshop from Virginia Avery—"Sixteenth Century Japanese Patchwork Jacket." I quickly realized how easily this garment could be adapted for knitting and how abundant the design possibilities were. A knitted version has several other things going for it.

- It provides an essentially patternless scheme for knitters who say they cannot work without a pattern.
- It presents a great opportunity for knitters who have accumulated a yarn stash (most of us).
- It is knitted in strips, which makes it a wonderfully portable project.

I was sure this new idea would excite and delight knitters, and that it would make a great group project as well. In September 1998, I brought the idea to our guild, the North Coast Knitters, of which I am president and Phyllis Bates is secretary. I took my finished fabric garment and shared my sweater-in-progress to see what the response would be. I passed out a sketch and the following instructions.

1. Determine your color scheme. This is a great opportunity to use tidbits and odd balls of yarns in your stash.
2. Determine the garment width you want and divide by five. If you want a garment twenty-five inches wide, then each strip will be five inches wide. Now this is where your needle size and gauge comes in. I suggest that you use the needle size you are comfortable with, taking into consideration the types of yarns you will be using. Experiment until you find out how many stitches you need to cast on to get the width you desire. It will probably be anywhere from 16 to 22. If you plan to crochet the strips together, you don't need a seam allowance stitch.



This is the fabric garment Colleen made in the workshop.

3. Determine garment length by measuring from the desired point for the hem in front, over the shoulder, and back down to the desired hem point in back. Knit four strips this length. Knit a fifth strip for the center back that is one-half the length of the other four minus one inch. Do the band in front using half the width of the other strips and make it a few inches longer to accommodate the back neck width.
4. The sleeves are simple 13" x 27" (33 x 68.5 cm) rectangles for all sizes. They are folded diagonally at one end and horizontally at the other (see diagram, page 62), and finish slightly below the elbow. If you want a longer sleeve, add an extension after you've done the sleeve seam.
5. Add pockets on the two front strips (next to the neckband) before you assemble the garment. The neckband is one-half the width of the strips and a bit longer—long enough to go around the neck.

I knew the TKG Convention was coming to San Diego in March of 1999 and I thought that if I could stir up enough interest in this project, we could gather as a group at the convention banquet, each wearing our version of the sweater. The idea caught on and the knitting began.

A short time later (October 1998), I was asked to chair the banquet fashion show and decided to showcase our Asian-style jackets at the end. Two members of our group knitted two jackets each in time for the show. I knitted two for myself in addition to the original one I'd knitted for my sister. I am still exploding with ideas for more and hope to share my enthusiasm elsewhere. It has been a delight for me to see the different versions emerge. I call the design the Knitted Kimono Jacket. Give it a try. ∞

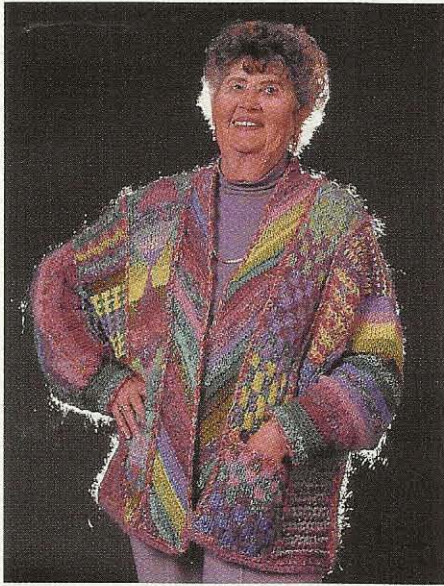

Colleen Davis

This is the original Knitted Kimono Jacket inspired by my sewing class. I thought it would be the perfect canvas on which to play with different stitches and create an artistic gift for my sister June Johnson's birthday. I used her favorite color, mauve, along with dusty blue, rose, pink, pastel green, and lavender. To liven up the scheme I added lime green and yellow.

I decided to knit two and a half strips using different slip stitches, one checkerboard strip, one strip with a diamond design, and one half strip with a triangle design. I knitted one sleeve in vertical stripes and one in horizontal stripes.

After I crocheted the body of the sweater together, I analyzed it to determine the band design. I thought a bias stripe would look good and also give some firmness to the band.

The idea of using different design ideas without a pattern was not something new for me. I enjoy creating a sweater as I go by using "modules" with different designs. However, the potential for using this format to teach and inspire other knitters to try working without a pattern was obvious. Once I was "into it," given the format of these strips and rectangles, all kinds of design ideas popped into my head.

Florence Griffin

When Colleen showed us her lovely sixteenth-century fabric patchwork jacket and suggested knitting one using our stashes of yarns and newly learned slip stitches, I knew I had to do it. An easy-to-fit garment was also an enticement. But having been a traditional knitter for sixty-four years, one who followed pattern instructions exactly, varying only for size, at first this was a challenge for me. Also, I wanted to be true to the use of seventeen brocades in the original fabric jacket—another challenge.

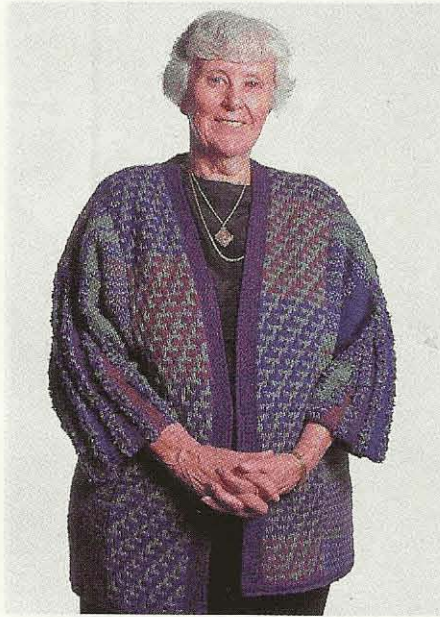

With encouragement from Colleen and others in our group, I found I could achieve a harmonious patchwork effect using just four stitches and five different yarns (using colors of the same value Colleen recommended) to produce the seventeen variations. In each strip, there is just one type of stitch, either stockinette, garter, woven, or tongue and groove, with the colors and their proportions varied at whim. This project freed me to mix yarns and colors and knit happily ever after.

Colleen Davis

After knitting the jacket for my sister shown above, I decided to knit one for myself using more intense, glitzy colors. I had accumulated a nice collection of purple yarns and began to think about a good contrasting color. Instead of going directly across the color wheel, I moved one notch to the side of yellow and chose yellow-orange.

I had recently helped a friend, Sara Stolz, renew her interest in knitting by showing her Kaffe Fassett's method of using many, many colors within one geo-

metric shape. We decided to work with a diamond. Knitting strips for this same Kimono Jacket, Sara used one colorway within the diamond and a contrasting colorway outside.

After working with Sara, I got the urge to use this same technique with my purple and yellow-orange. The body is composed of large shaded diamonds, with small diamond insets on one sleeve and diagonal lines on the other. For the band I picked up stitches around the neckline and knitted in a stripe pattern in garter stitch.

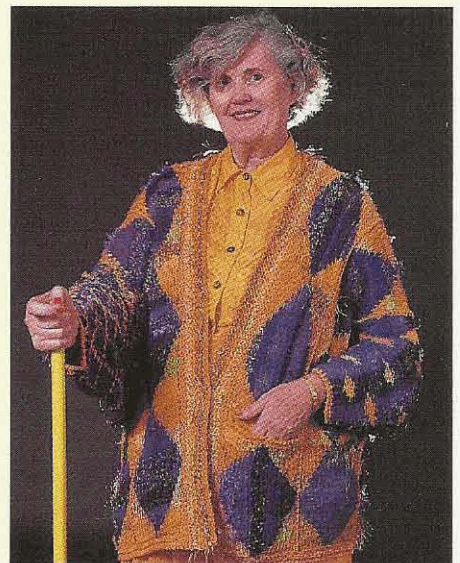

Phyllis Bates

When Colleen presented this idea, I remembered yarn I had purchased several years ago on vacation. I started to swatch, trying several patterns from Alice Starmore's *Fair Isle Knitting*. I also tried several slip-stitch patterns from Barbara Walker's books, looking for something that would be compatible with the Fair Isle. Because I was working in a strip, it was easy to rip out unwanted segments and start again.

I continued a trial-and-discard process. Once I made a choice, I repeated elements for balance. I knitted a second strip like the first (except when I changed it), but turned it in the opposite direc-

tion, i.e., with the cast-on edge at the back. I was falling behind the rest of the group.

Figuring out how to achieve my desired results with only the yarns I had on hand was a challenge. The number of balls of the main color was dwindling fast, and necessity dictated the striped portions of the sleeves. Trial and error has always been part of my knitting/designing process, but I've never had so many different techniques and patterns in one garment before. My jacket is quite different from the others, and I am satisfied with the results. Besides the pleasure we all got from our work, the project promoted a sense of group identity.

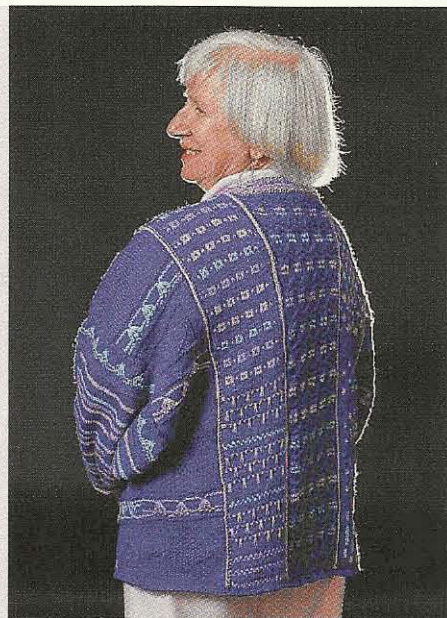

Sara Stolz

Colleen's creative themes and unique color combinations inspired me to get back to knitting after a lapse of many years. The simplicity of knitting strips made the project comfortable—because I was working with fewer stitches, it was not so discouraging to “unknit” if I made an error or did not like a color, and I learned to be more adventurous with my combinations. I love the freedom of knitting with strips and changing a color or pattern when I



want to. Now I have a hard time putting my knitting down because I just have to see how that next yarn will look.

A Note from Colleen

For this diamond pattern, Sara used intarsia, which she had never done before. She knitted one sleeve in horizontal stripes and the other in vertical stripes. She knitted the neckband on the bias in stripes, and added buttons and buttonholes.



Jeanne Trusso

I heard Colleen Davis talk at a luncheon where she mentioned Virginia Avery's sixteenth-century patchwork jacket. My ears perked up—I'd attended the same class and had done Virginia's jacket in a variety of fabrics. When Colleen suggested knitting the jacket, I was instantly stimulated. I had been burned out on knitting for about twenty years, but had recently felt the urge to knit again. What timing!

I'd had a knit shop years ago, so I was well endowed with all kinds of yarn, and

the patchwork jacket was perfect for using some up. As soon as I got home from the luncheon, I tore into the drawers and bins where I'd stored my yarn by color. I decided on purple, red, and turquoise because I was in that kind of mood (excited). I immediately started a panel and knitted obsessively most of the night. The next day I ripped out what I'd done and started again. Geometric patterns developed as I went.

What a fun project. I am definitely back to knitting and am planning my next jacket in neutral colors.



Anna Walden

Since my first jacket (shown on page 62) was so much fun to knit, I made another in three colors—purples, pinks, greens, plus a lot of others. I chose a patchwork theme, like the original fabric version. The strips are done in whirling star, modified log cabin, pennants, strip piecing, and nine-patch. One sleeve is an “around-the-world” pattern, grading through all the colors in the jacket; the other is crazy quilt that includes embroidery.

I am not sure this project altered my way of knitting, but it certainly carried

me farther down the road I have been traveling. I really love “modular” knitting, which is what I call post-modern knitting deconstructed from traditional techniques. I like the freedom of working with color and design without having to start at one part—top, bottom, or cuff—and work to the other end. I like to build my design as I go, adding what pleases the eye, and the strips in this jacket are ideal for this method. You can change what you are doing with each section, playing with color and design so that it never gets boring.

Colleen Davis

I had been thinking of putting orange and turquoise together for a long time and decided to use some wonderful brown yarns from my stash to bridge these colors, which are opposite on the color wheel.

The jacket comprises vertical stripes within the strips. I knitted a three-stripe block followed by a five-stripe block, and between the blocks I did a few rows of garter stitch in a very nubby multicolored yarn. So both the length and width of the stripes were varied.



I altered the sleeve construction on this one because I wanted all vertical stripes. One sleeve is knitted in turquoise stripes and one in orange stripes. I love the effect. I also wanted a really unusual band. Because the sweater has so much texture, I decided to expand and make *more* texture. I made the band with five-stitch bobbles very close together. It took me almost as much time to knit the band as it did to knit all the other parts of the sweater combined!

Joan Knute

Colleen gave me my inspiration. She motivates the whole group to step out of the ordinary into a place where all things knitted are possible—in whole or in part.

My colors came from my stash. I had lots of teals and almost as many purples, and used about half of them in this jacket.

A Note from Colleen

After Joan completed her sweater, she brought up a very obvious point I'd

neglected to put in the instructions. It was something I took for granted (because I always do this): first do a sketch of your jacket, writing in your dimensions and measurements and noting possible design ideas. You may not be able to determine what you want to do on the sleeves or the band right at the beginning. Ideas for those treatments can evolve as you cruise along on the five strips. If you're hesitant to do a sketch, just trace the outline of the diagram provided on page 62.



Design Ideas

Design possibilities are endless—from conservative to wild. Here are some of the ideas I have, and there are many, many more.

- ◆ Crazy quilt strips.
- ◆ Blocks of different cable, slip, mosaic, or geometric patterns. You could knit garter-stitch rows between the blocks.
- ◆ Checkerboard strips or blocks.
- ◆ Diagonal (or bias) squares or strips.
- ◆ Triangles, diamonds, rectangles, and/or squares.
- ◆ Free-form strips.
- ◆ Plain strips with relief patterns strategically placed.
- ◆ Lace strips alternating with plain strips.
- ◆ Sampler of mosaic or slip stitches.
- ◆ A theme such as faces, shoes, teddy bears, or flowers.
- ◆ Entrelac.
- ◆ Smocking design with shaded colors underneath.
- ◆ Vertical or horizontal stripes.
- ◆ Blocks of intarsia patterns.
- ◆ Animal prints.
- ◆ Regional geographic designs such as Southwest motifs.
- ◆ Plain strips with knitted or crocheted appliqués.
- ◆ Mitered squares or rectangles.
- ◆ Squares within squares.
- ◆ Machine-knitted strips combined with handknitted strips.
- ◆ Crocheted strips combined with knitted strips.



Sara Stolz

I knitted my second sweater in the same diamond pattern as the first, but my palette was black, white, and gray, with zingers of hot pink.

Anna Walden

Colleen's original idea was to incorporate some slip stitches we had learned at a guild meeting into the simple Asian-style jacket shape. I was also trying to meet a challenge issued by the Wearable Arts Council of San Diego to make something in black and white and one other color. This project seemed ideal for that color scheme. I used two slip stitches, entrelac, and Fair Isle triangles for the four strips. Then I used a mosaic design for the back strip and neck/front band. One sleeve is different size stripes and the other is a zigzag (bargello) pattern.

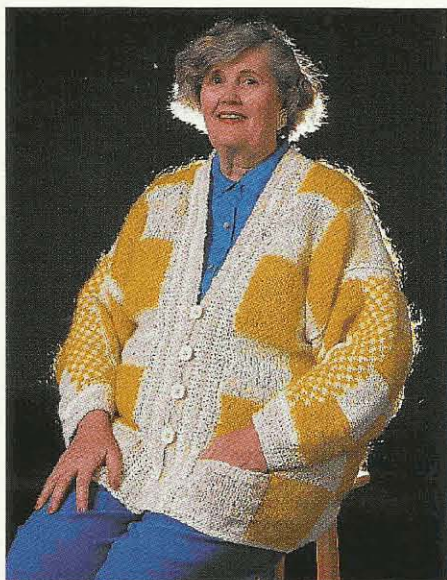

Colleen Davis

After knitting the jacket for my sister and the diamond one, I knew I had to press on. My yellow skeins called to me. As much as I love rich, intense colors, I thought this particular yellow needed to be toned down, and since I also had many bits and pieces of off-white yarns, I decided a big yellow and off-white checkerboard would be fun. I used solid yellow squares opposite squares of varied off-whites. When I knitted the sleeves I did a couple of inches of tiny checkerboards at one end. This version was a "no-brainer" once I figured out the measurements.

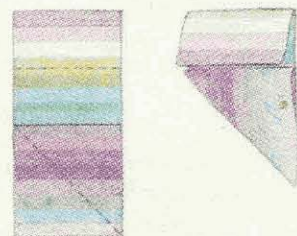

Trace this diagram to plan your own kimono. See page 58 for instructions to calculate the measurements.

BLUE HERON YARNS

SPECIALIZING IN
HAND PAINTED YARN
COTTON
RAYON
SILK
WOOL
CHENILLE

Barbara Lundy Stone Designs
215 Wye Ave.
Easton, Maryland 21601
(410) 820-7471
visit our online store at:
www.barbaralundystone.com

Call Toll Free (800) 523-WOOL

or visit our website at
www.hanekewoolfashions.com

When the time comes for your next very special project,
the one that you have been planning forever, it is time
to consider the best in natural fiber yarns.
It is time to consider Haneke Wool Fashions,
the natural fiber yarn specialists.

Free Knitting Kit Catalogs available • Sample Cards available for \$8.00 US

Haneke Wool Fashions

Boutique & Yarn Shop
630 North Blackcat Road • Meridian, Idaho 83642

Your Satisfaction Guaranteed!

NEW!



Wooden Knitting Needles

FibreTECH's new needles are the environmental choice for today's knitter. They are made with windpower alone out of a renewable resource. The hardwood has a light finish that is pleasing to touch. Enjoy our single and double pointed needles on all types of yarns. We are proud to offer sizes ranging from 8" children's needles to 16" needles. Nothing fancy, just good wood tools.

Natural, Simple and Cost-effective

Prices start at \$4.60 ♦ Call for a catalog
Or ask for our products at your local shop

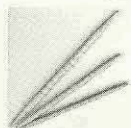

Wooden Cable
Needles
ONLY \$10.00

FREE
SHIPPING!



Needles-N-Things
Organizer
ONLY \$25.00

FibreTECH

www.thetechgroup.net/fibre.htm
248 Harbor Blvd. Belmont, CA 94002
650.610.0554 phone 650.610.0557 fax
Send check or call for MC, Visa, Amex, Disc
Shipping included, CA residents add tax
Wholesale Inquires Welcome

NEEDLE CASES



For single points, double points, a single project, and circulars. Contemporary print fabrics are used with a sturdy canvas interior for the needle pockets. The circular needle case uses clear, heavy plastic pouches in a book-like format. Excellent quality. Colorway options: blue, jeweltone, autumn, teal. Please add \$4.75 shipping. Need a catalog? Just ask!

Single Point Case: holds 10 pairs \$25.00

Double Point Case: holds 15 sets \$25.00

Circular Case: holds 12 sets \$42.00

Project Pouch: choose for single point, double point, or circular \$16.00



Call 1-800-468-0035
YARN BARN

930 Massachusetts Lawrence KS 66044



ANDHRA PRADESH VEST

DIANE ZANGL

Worked side to side

Zipper opening

FINISHED SIZE 38 (40, 42, 44)"
(96.5 [101.5, 106.5, 112] cm)
bust/chest circumference. Vest
shown measures 40" (101.5 cm).

YARN Dale of Norway Tiur (60%
mohair, 40% wool; 127 yd (115 m)/
50 g): #4136 red (MC), 3 (3, 4, 4)
balls; #0090 black, 2 balls; #2512
light peach, #3436 orange, #2526
gold, #0020 natural, #2343 khaki,
1 ball each.

NEEDLES Size 4 (3.5 mm). Adjust
needle size if necessary to obtain
the correct gauge.

NOTIONS Stitch markers (m);
#00 (3.5 mm) steel crochet hook;
14 (14, 16, 16)" (35.5 [35.5, 40.5,
40.5] cm) separating zipper; match-
ing sewing thread; tapestry needle.

GAUGE 24 sts and 28 rows = 4"
(10 cm) in color pattern; 26 sts and
31 rows = 4" (10 cm) in St st.

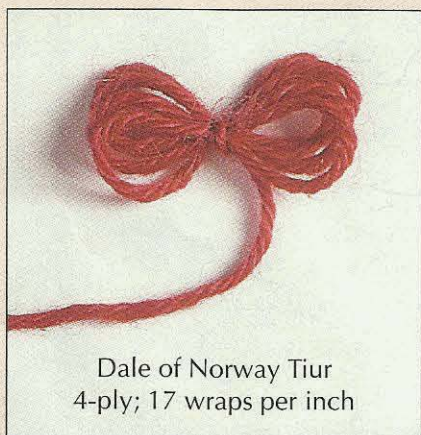

Dale of Norway Tiur
4-ply; 17 wraps per inch

WHEN I CAME ACROSS a
volume on textiles of India, the
rich visual images just begged
to be translated to knitting. One in par-
ticular, from Hyderabad in the Andhra
Pradesh region, especially caught my eye.
It is single ikat—striped and chevron cot-
ton yardage available in urban markets.

I've translated the colors and patterns
into this vertically-striped Fair Isle vest.
(Talk about a mix of cultures!) Consisting
of two major pieces, the vest begins at cen-
ter back and is worked to center front. The
second side mirrors its twin. Shoulders are
joined with a small section of main color.
The armholes, front and lower edges, and
collar are finished with rows of single cro-
chet. The bottom edge falls slightly below
the waist.

•**Left Half:** With MC and using the pro-
visional method (see Glossary, page 7), CO
92 (92, 102, 102) sts. Work as charted
until piece measures 6 (6¼, 6½, 7)" (15
[16, 16.5, 18] cm) from beg, ending with
a WS row. **Shape armhole:** (RS) BO 39
(42, 45, 45) sts, work to end—53 (50, 57,
57) sts rem. Dec 1 st at arm edge every
other row 3 times—50 (47, 54, 54) sts rem.
Work even until piece measures about 6½
(6½, 7, 7)" (16.5 [16.5, 18, 18] cm) from
BO edge, ending with a WS row. Then inc
1 st at arm edge every other row 3 times
ending with a WS row—53 (50, 57, 57)
sts rem. Using the cable method (see Glos-
sary, page 7), CO 39 (42, 45, 45) sts at beg
of next RS row—92 (92, 102, 102) sts.
Work even until front shoulder measures
2¾ (3, 3, 3½)" (7 [7.5, 7.5, 9] cm), ending
with a WS row. **Shape front neck:** (RS)
BO 6 sts, work to end. Dec 1 st at neck
edge every other row 3 times—83 (83, 93,
93) sts. Work even until neck measures 1¾
(1¾, 2, 2)" (4.5 [4.5, 5, 5] cm) from neck
BO. Then dec 1 st at lower edge every

other row 7 (7, 8, 8) times—76 (76, 85,
85) sts rem. Neck should measure ¾ (¾,
¾, ¾)" (8.5 [8.5, 9, 9] cm). BO all sts.

•**Right Half:** Remove provisional CO and
place live sts onto needle, picking up an
extra half st at left end—92 (92, 102, 102)
sts. Join MC. Work as for left half, revers-
ing shapings.

•**Shoulder Straps: Right shoulder:** With
MC, RS facing, and beg at right back arm-
hole, pick up and knit 20 (22, 22, 25) sts,
turn, purl these sts, CO 1, pm, CO 16, pm,
CO 1, pick up and purl 20 (22, 22, 25) sts
across right front shoulder, turn, K19 (21,
21, 24), *k2tog, k16, ssk, sl 1 wyib, turn,
ssp, p16, p2tog, sl 1 wyif, turn. Rep from *
until all picked up sts have been worked—
18 sts rem. BO all sts. **Left shoulder:** With
MC, RS facing, and beg at left front arm-
hole, pick up and knit 20 (22, 22, 25) sts.
Work as for right strap, reversing shapings.

•**Finishing: Arm edging:** Join MC at
underarm. Keeping work flat, work 1 row
sc (see Glossary, page 8, for crochet in-
structions) around armhole, join with sl
st. (Note: I worked about 2 sc for every 3
rows or sts; your rate may vary slightly.)
***Next row:** Ch 1, 1 sc in each sc around,
join with sl st. Rep from * once. Block vest
lightly. **Neck, front, and lower edging:**
With MC and beg at center back neck,
work 1 row sc around neck, down left
front, across lower edges, and up right
front, ending at center back neck, keep-
ing edges flat and easing neckline to mea-
surements indicated on schematic. **Collar:**
With MC, RS facing, and beg at right front
edge and ending at left front edge, pick up
and knit 120 (120, 130, 130) sts around
neckline. (Note: You will have to pick up
sts in both front and back loops of crochet
sts to obtain proper st count.) Mark cen-
ter st of each shoulder strap. Working in
St st, knit to second m, wrap marked st

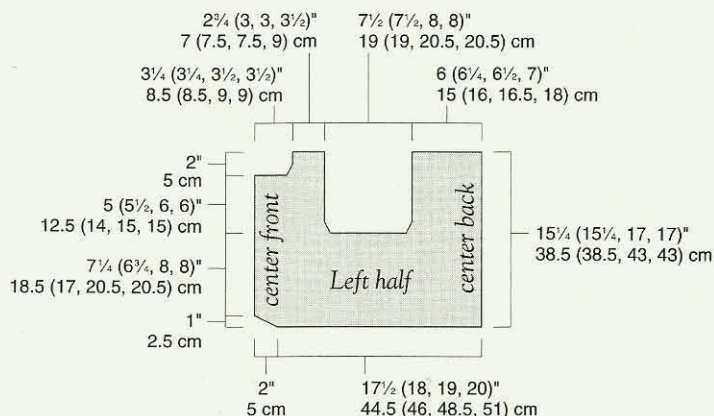



(see Glossary, page 9), turn, purl to m, wrap marked st, turn, *knit to 6 sts before previous wrap, wrap next st, turn, purl to 6 sts before previous wrap, wrap next st, turn. Rep from * once. *Next row:* Work across all sts, working the wraps tog with the wrapped sts. Work even in St st until collar measures 3" (7.5 cm), at front edge. BO all sts. **Collar edging:** With RS facing, join MC at left edge of collar. Mark corners sts of collar. Keeping work flat, work sc around collar making 2 sc in each marked corner st. Ch 1, turn, sc in each sc, working 2 sc in each corner st. Cut yarn and fasten off. **Body edging:** Mark lower and upper front corner sts. *Join MC at left neck edge. Work 1 sc in each sc of previous rnd, working 2 sc in each marked st and ending at left neck edge. Cut yarn. Rep from * once. With matching thread, sew zipper to front edges. Block vest again, steaming collar so that it rolls over. ∞

Diane Zangl is a freelance knitwear designer who works with national magazines and yarn companies. Besides textiles, her interests include history and geography. Her ideal situation would be a trip to a faraway country studying antique textiles and ancient cultures.

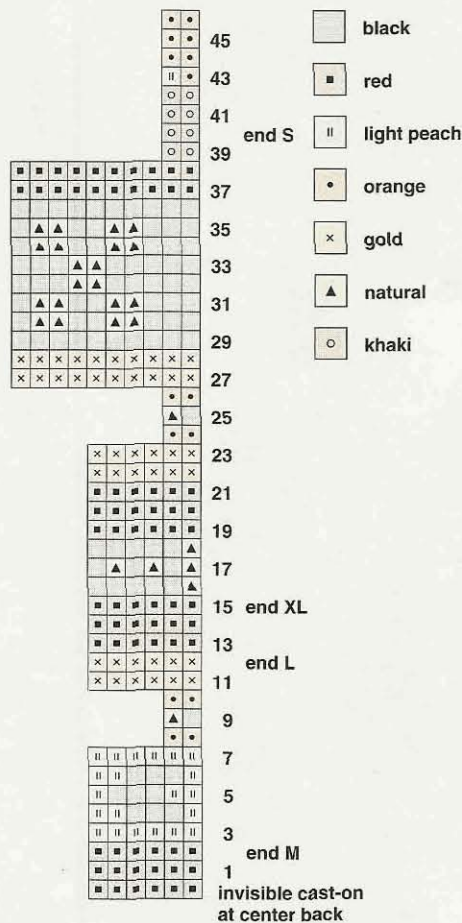

ZIP IT UP!

Zipper closures are an excellent choice when a plain closure is in order, as in the Andhra Pradesh Vest here or the Maghrib Vests on page 23. With a bit of care, you can sew a zipper into knitted fabric as successfully as you can into woven fabric. However, to avoid puckers, you must sew the zipper in by hand. Before you start, preshrink the zipper and finish the edge of the knitted fabric by working a row or two of crochet, I-cord, or by folding the edge to the wrong side.

Working from the right side and beginning at the base, pin each side of the closed zipper to the wrong side of the knitted fabric so the edges of the knitting come together and hide the teeth. Take care to keep the zipper flat and at the same position on both sides. With contrasting thread, baste the zipper in place close to the teeth (figure 1).

Remove the pins. Turn the work over and use coordinating thread to whipstitch the edges of the zipper to the wrong side of the knitted fabric (figure 2), making sure that the stitches do not show on the right side. Turn the work back to the right side. With coordinating thread and using a backstitch, sew the knitted fabric to the zipper close to the teeth (figure 3).

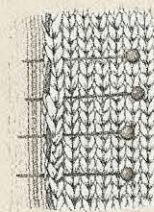

figure 1

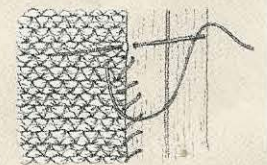

figure 2

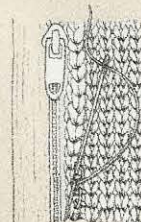

figure 3

ROWAN yarns

A World Of Color At Your Fingertips



ROWAN

FALL/WINTER MAGAZINE #26

Featuring over 30 new designs by top British designers, Kaffe Fassett, Kim Hargreaves, Louisa Harding, Jean Moss, Martin Storey, Sharon Peake, and Brandon Mably.

For a list of yarn stores carrying the Rowan Pattern books, yarn and knit kits, please contact:

Westminster Fibers
 5 Northern Boulevard
 Amherst, NH 03031
 (603) 886-5041



Wonder Jacket by Kim Hargreaves
 in Rowan Magpie & Wool Cotton

A Note on Ikat

Ikat textiles are among the most prized fabrics in the world. Respected for their brilliant colors and their complex patterns, they have been woven in India since the sixth century.

The term *ikat* derives from the Malay word *mangikat*, which means to bind, knot, or wind around. In its simplest definition, ikat is a form of resist dyeing that involves a sequence of tying and dyeing sections of bundled thread into a predetermined color scheme. Dye penetrates the exposed sections, while the tied ones remain undyed. This patterned thread is then woven into fabric.

There are three basic forms of ikat. In single ikat, either warp or weft threads are tied and dyed. Combined ikat contains both warp and weft ikat threads coexisting in different parts of a fabric and occasionally overlapping. Double ikat is the most complex. In this method both warp and weft threads are tied and dyed with such extreme precision that, when woven, threads mesh exactly at certain points to form a complete and complex pattern. Many ancient cultures practiced single ikat techniques, but the more elaborate double ikat appears only in India, Bali, and Japan.

Introduced only two or three generations ago, the ikat technique is relatively new to the weavers of Andhra Pradesh, an

eastern state on the Bay of Bengal whose capital is Hyderabad. Today ikat textiles are woven in at least forty villages within a fifty-mile radius of Hyderabad. The mastery of this difficult precision craft in so short a time reflects the fact that ikat weaving has become a way of life in Andhra Pradesh. From grandparent to child, every family member is involved in the process, and Andhra Pradesh today is the largest Indian exporter of ikat textiles.

Displaying an interest and pride neglected during the British Raj, affluent Indian urbanites have recently discovered the country's ikat heritage. Ironically, the ikat weavers, while keeping this heritage alive, are also at the mercy of the whims of fashion. In earlier times they were craftspeople and artists; no boundaries existed between skill and creativity. Today, however, fast-changing lifestyles and the opening up of urban and international markets have made it mandatory for ikat design houses to assume the creative aspects of textile design. While the weaver's job is now one of pure craftsmanship, we can be grateful that these jewels of ikat beauty continue to exist.

Source:

Desai, Chelna. *Ikat Textiles of India*. San Francisco: Chronicle Books, 1988.



♥ Grand View Country Store ♥

U.S. Rt. 2 Randolph, NH 03570

A UNIQUE YARN SHOP!

All the best is right here in the scenic White Mountains of New Hampshire. Add us to your travel agenda or send \$4.00 to subscribe to our Newsletters of yarns, books and original knitting kits. Free knitting pattern in each.

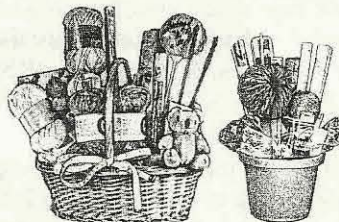

The Gift Basket Department

When you want to give (or receive) a very special gift, order a gift basket—Custom designed just for you or your special knitter. Great for any occasion, we ship anywhere. A truly unique gift. Call us to place your order. Prices range from \$29.99 and up.



Come for "2 Days in a Yarn Shop!"
"Mountains, Muffins and Mohair"

♥ Grand View Country Store ♥ Rt. 2, Randolph, NH 03570 1-800-898-5715



Easy Knit V-Neck Cardigan Vest

Classic shaping and an easy K1, P1 and garter stitch pattern. Styled for *him or her!*
Worsted Wt, 4sts=1", #5 & #7.
100% Wool in Denim, Lt Sheep Grey, Natural, Mt. Blue, Garnet, Dk Jade, Thistle, Green Heather or any one of Bartlett's 74 colors.
Acorn or Pine Cone Buttons \$7.
Fin. Sizes: 34"-38" \$22
42"-46" \$28 s/h \$6.95
Pattern Only \$3.50 s/h \$1.95
Also in cotton or Acrylic blend.
Call for colors and prices.

Index of *Grand View* patterns—descriptions, pictures and prices. Also includes designs featured in past *Interweave* Issues. \$3.00
Newsletter & Index only \$6
Lodging available.
1-603-466-5715

your creations are your Yarn Expressions come to us for project materials from

Alice Starmore	Dale of Norway	Mountain Colors
Berroco	Hanne Falkenberg	Plymouth Yarns
Classic Elite	Jo Sharp	Swedish Yarns
Colinette	Lorna's Laces	Rowan



We feature Michele Wyman patterns

Designs with a timeless style that only *look* difficult to complete. A joy to work with because they include...

- ... thorough, easy-to-follow directions
- ... words and charts
- ... detailed schematics
- ... "real people" size ranges
- ... information for you to work with whatever darn yarn you'd like!

S035 Providence Pullover

ORDER LINE 1-800-283-8409

Yarn Expressions 7914 S Memorial Pkwy Huntsville, AL 35802

on-line catalog at www.YarnExpressions.com



PETROGLYPH

JILL WOLCOTT

Ruffled ribbing

Dolman sleeves

FINISHED SIZE 34 (38, 42, 46, 50, 54)" [86.5 [96.5, 106.5, 117, 127, 137] cm] bust/chest circumference, buttoned. Sweater shown measures 38" (96.5 cm).

YARN Meunch La Plata (100% pure new wool; 142 yd [130 m]/50 g): #10 green, 8 (9, 11, 11, 12, 13) balls or Tahki Yarns Chelsea Silk (65% wool, 35% silk; 105 yd [96 m]/50 g): #0162 gray, 11 (12, 14, 15, 16, 18) balls.

NEEDLES Body and Sleeves—Size 7 (4.5 mm); Ruffle—Size 5 (3.75 mm): 47" (120-cm) circular (cir). Adjust needles sizes if necessary to obtain the correct gauge.

NOTIONS Markers (m); stitch holders or waste yarn; tapestry needle; two 1½" (3-cm) buttons.

GAUGE 17 sts and 24 rows = 4" (10 cm) in St st and pattern st on larger needles.



Meunch La Plata
2-ply 6-strand; 9 wraps per inch



Tahki Chelsea Silk
2-ply; 11 wraps per inch

THE PETROGLYPHS that inspired this piece are found on the beautiful islands of Hawaii. Unlike photographs I've seen, the real thing can be difficult to make out due to weathering and the crudeness of the carving. The figures I've used here are also indistinct at a distance, but even so they provide a nice textural pattern to break up flat stockinette stitch. In knitting this piece, you get to practice working purl-stitch motifs, short rowing, knitting in the round, and knitting into the fronts and backs of stitches.

This sweater is relatively easy to knit, but does require concentration. The petroglyph motifs are staggered along the front edge, which is shaped by short rows (as are the shoulders). The sides are slightly tapered out from the waist to the armhole and give the sweater a fitted look. All edges are outlined with a row of purl stitches and then finished with 3/3 rib ruffles. The dolman sleeves are worked from the armhole down. I've given directions for both 3/4-length sleeves and full-length ones.

Note: If you have trouble purling two stitches together through the back loops (p2tog tbl), slip the stitches individually, twisting them as you do so, return them to the left needle, and then purl them together through the back loops.

•**Back:** With larger needles, CO 64 (77, 83, 92, 98, 107) sts. Knit 1 (WS) row. Beg with a knit row, work 4 rows St st. **Petroglyph set-up:** (RS) K2 (1, 4, 1, 4, 1), work 60 (75, 75, 90, 90, 105) sts according to Chart 1, k2 (1, 4, 1, 4, 1). Cont as established, working edge sts in St st and center sts according to chart, and *at the same time*, beg with Row 1 of chart, inc 1 st each end of needle on this and then every foll 4 (6, 6, 8, 8, 10) rows a total of 5 (4, 5, 4, 5, 5) times—74 (85, 93, 100, 108, 117) sts. Cont in St st until piece measures 5 (5½, 6, 6½, 7, 7½)" (12.5 [14, 15, 16.5, 18, 19] cm) from beg, or desired length to armhole (excluding ruffle), ending with a WS row. **Shape armholes:** Using the cable method (see Glossary, page 7), CO 3 sts at beg of next 4 rows, then CO 3 (1, 1, 2, 2) st(s) at beg of foll 2 rows—92 (99, 107, 116, 124, 133) sts. Work even until a total of 69 (79, 87, 91, 107, 113) rows have been worked and piece measures 11½ (13¼, 14½, 15¼, 17¾, 18¾)" (29 [33.5, 37, 38.5, 45, 47.5] cm) from beg, ending with a WS row. K47 (49, 53, 58, 62, 68), using the

M1 method (see Glossary, page 9), inc 1 (0, 0, 1, 1, 0) st, knit to end—93 (99, 107, 117, 125, 133) sts. Purl 1 row. **Patt set-up:** (RS) K39 (42, 46, 51, 55, 59), beg with Row 1, work center 15 sts according to Chart 1, k39 (42, 46, 51, 55, 59). Work through Row 20 of chart. Knit 1 (RS) row—92 (102, 110, 114, 130, 136) rows total; piece should measure 15¼ (17, 18¼, 19, 21½, 22½)" (38.5 [43, 46.5, 48.5, 54.5, 57] cm) from beg. **Next row:** (WS) P40 (42, 45, 50, 53, 57), [k1 tbl] 13 (15, 17, 17, 19, 19) times, purl to end. **Shape neck:** K35 (37, 40, 45, 48, 52), [p1 tbl] 5 times, join new yarn and BO 13 (15, 17, 17, 19, 19) sts for back neck, knit to end—40 (42, 45, 50, 53, 57) sts each side. Place left shoulder sts on holder. **Right shoulder:** (Beg all short rows with WS facing.)

Short-row 1: BO 4 sts, p27 (28, 30, 34, 36, 40), wrap next st (see Glossary, page 9), turn, knit to last 4 sts, [p1 tbl] 4 times—36 (38, 41, 46, 49, 53) sts rem.

Short-row 2: BO 3 sts, k1 tbl, p15 (15, 17, 19, 22, 24), wrap next st, turn, knit to last 2 sts, p1 tbl, k1—33 (35, 38, 43, 46, 50) sts rem.

Short-row 3: P1, k1 tbl, p7 (7, 8, 9, 11, 12), wrap next st, turn, knit to last 2 sts, p1 tbl, k1.

Next row: Work across all sts, working wraps tog with wrapped sts.

Place sts on holder. **Left shoulder:** Purl to last 5 sts, [p1 tbl] 5 times. Work as for right shoulder, reversing shaping and beg short rows with RS facing.

•**Left Front:** CO 49 (52, 55, 60, 65, 69) sts. Knit 1 row (WS). Note: Before preceding, read through the rest of these instructions carefully—you will shape the lower front edge at the same time you set up and work the charted patt and shape the side edge. **Shape lower front edge:** (RS) K20 (24, 23, 23, 28, 32), wrap next st, turn, purl to end of row. On next row, [work to wrapped st, knit st tog with wrap, k2, wrap next st, turn, work to end of row] 7 (7, 9, 9, 10, 10) times, then [work to wrapped st, knit st tog with wrap, k1, wrap next st, turn, work to end of row] 3 (3, 2, 3, 3, 3) times, and *at the same time*, after working 4 rows of St st, (RS facing) k1 (1, 2, 6, 2, 2), pm, work next 11 sts in petroglyph motif according to Chart 2, and inc 1 st at side edge every 4 (6, 6, 8, 8, 8) rows 5 (4, 5, 4, 5, 5) times as for back, working new sts in St st. On Row 3 (5, 7, 5, 3, 5) of chart, work across first 12 (12, 13, 17, 13, 13) sts as



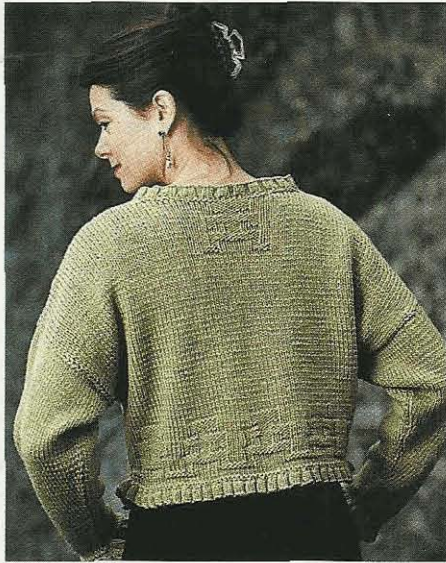

established, k0 (1, 2, 2, 1, 2), then beg with Row 1, work a second petroglyph (Chart 2) over next 11 sts. On Row 7 (9, 11, 11, 7, 9) of first petroglyph, work to end of second petroglyph, k0 (1, 2, 2, 1, 2), then beg a third rep over next 11 sts. On Row 9 (15, 17, 19, 11, 15) of first petroglyph, work to end of third petroglyph, then beg a fourth petroglyph over next 11 sts. For sizes 50 (54) (127 [137] cm) only: On Row 19 (17) of second petroglyph, work to end of fourth petroglyph, k1 (2), then beg a fifth petroglyph over next 11 sts. For all sizes: From here on, work twisted rev St st detail at front edge as follows: On RS rows, work to last 2 sts, p1 tbl, k1; on WS rows, p1, k1 tbl, work to end. Cont in patt until piece measures 5½ (6, 6½, 7, 7½, 8)" (14 [15, 16.5, 18, 19, 20.5] cm) from beg, ending with a WS row, working St st after Row 20 of each chart rep. **Shape neck:** (RS) Dec 1 st at neck edge (work to last 3 sts, p2tog tbl, k1) every other row 30 (25, 24, 21, 23, 21) times, then every 4 rows 0 (3, 5, 8, 9, 11) times. At the same time, when piece measures 5½ (6, 7, 8, 9, 10)" (14 [15, 18, 20.5, 23, 25.5] cm) from beg, ending with a WS row, **shape armhole** as for back at beg of RS rows (when incs are complete, there will be 14 [11, 12, 12, 13, 13] sts to the right of the m). At the same time, after completing the fourth (fourth, fourth,

fourth, fifth, fifth) petroglyph, work 2 rows St st, then set up patt along front neck as foll: **First neck patt set-up:** (RS) Knit to m, sl m, k23 (26, 28, 31, 39, 45), beg with Row 1, work next 11 sts according to Chart 2, work to end, cont neck shaping as established. Work 20 rows of chart, then work 2 (2, 4, 6, 2, 4) rows of St st. **Second neck patt set-up:** Knit to m, sl m, k15 (17, 17, 22, 30, 36), beg with Row 1, work next 11 sts according to Chart 2, work to end, cont neck shaping as established. Work 20 rows of chart, then work 2 (2, 4, 6, 2, 4) rows of St st. **Third neck patt set-up:** Knit to m, sl m, k6 (9, 11, 13, 24, 30), beg with Row 1, work next 11 sts according to Chart 2, work to end, cont neck shaping as established. Work 17 (17, 17, 17, 20, 20) rows of chart. For sizes 50 (54) (127 [137] cm) only: Work 2 (4) rows St st, then beg fourth neck patt as foll: Knit to m, sl m, k19 (24), beg with Row 1, work 11 sts according to Chart 2, work to end. Work 17 rows of chart—piece should measure 16¼ (17¼, 18½, 19¼, 21¾, 22¼)" (41.5 [44, 47, 49, 55, 56.5] cm) from beg—33 (35, 38, 43, 46, 50) sts. **Shape shoulders:** (WS) Working edge sts as established, work 24 (26, 28, 31, 34, 37) sts (remove m), wrap next st, turn, work to end. On next WS row, work 17 (18, 19, 21, 23, 15) sts, wrap next st, turn, work to end. On next row,

Chart 1

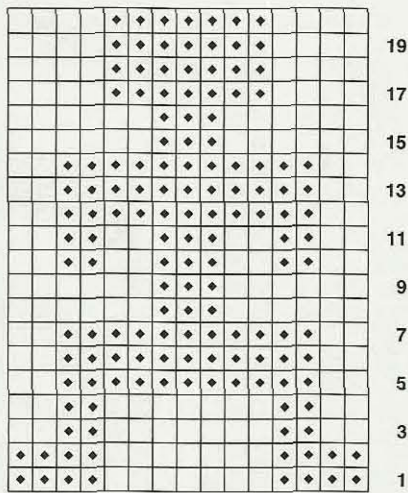

□ k on RS;
p on WS

◆ p tbl on RS;
k tbl on WS

Chart 2

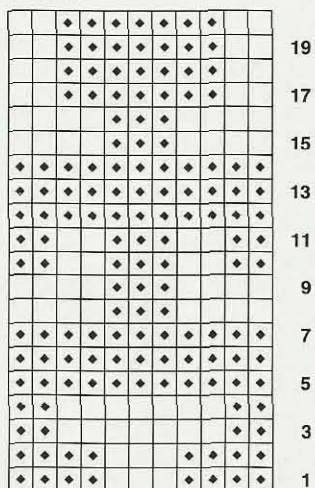

work 9 (9, 9, 10, 11, 12) sts, wrap next st, turn, work to end. On next row, work across all sts, working wraps tog with wrapped sts. Place all sts on holder.

•**Right Front:** Work as for left front, reversing shaping and working vertical buttonhole (see Glossary, page 9) 4 sts in from front edge for a total of 6 rows after 3 (4, 4, 5, 6, 6) rows have been worked beyond the end of hem shaping.

•**Sleeve:** Join fronts to back by BO shoulder sts tog (see Glossary, page 6). Pick up and knit 83 (87, 95, 101, 111, 119) sts around arm edge. Work 3 rows St st. **3/4-length version:** Dec 1 st each end of needle on next and then every other row 7 (11, 15, 20, 30, 34) times, then every 4 rows 13 (11, 9, 6, 1, 0) time(s), and *at the same time*, work St st until piece measures 9¼ (9, 8½, 8, 7½, 7)" (23.5 [23, 21.5, 20.5, 19, 18] cm) from shoulder, then beg with Row 20, work Chart 1 *in reverse order* over the center 15 sts. Work 5 rows St st, ending with a RS row. Knit 1 (WS) row—43 (43, 47, 49, 49, 51) sts rem. BO all sts. **Full-length version:** Work as for 3/4-length version, working decs and patt as foll: Dec every other row 6 (10, 15, 21, 32, 36) times, then every 4 rows 17 (14, 12, 8, 2, 0) times—37 (39, 41, 43, 43, 47) sts rem. *At the same time*, when piece measures 12 (11½, 11, 10, 9½, 9)" (30.5 [29, 28, 25.5, 24, 23] cm) from shoulder, beg with Row 20, work Chart 1 (*in reverse order*) over the center 15 sts. Work 5 rows St st, ending with a RS row. Knit 1 (WS) row. BO all sts. **Sleeve ruffle:** With smaller needle and RS facing, pick up and knit 1 st for each BO st. On next row (WS), k1f&b, *(k1f&b, k1) in next st; rep from *.

Row 1: (RS) *K3, p3; rep from *, end k2.
Row 2: P2, *k3, p3; rep from *.
Rep Rows 1 and 2, then work Row 1 while BO in patt.

•**Finishing:** Block. With yarn threaded on a tapestry needle, sew sleeve and side seams. **Body ruffle:** (worked in the rnd) With smaller needle, RS facing, beg at right shoulder, and working inside BO edge, pick up and knit 34 (36, 38, 40, 40, 42) sts across back neck, pm, pick up and knit 60 (62, 68, 72, 78, 84) sts along left front neck, pm, pick up and knit 3 sts in corner st, pick up and knit 12 (14, 14, 15, 17, 18) sts on left front, pick up and knit 3 sts in corner st, pm, pick up and knit 47 (51, 53, 59, 63, 67) sts along left front hem, pm, pick up and knit 61 (73, 79, 87, 95, 101) sts along back hem, pm, pick up and knit 47 (51, 53, 59, 63, 67) sts on right front hem, pm, pick up and knit 3 sts in corner st, pm, pick up and knit 12 (14, 14, 15, 17, 18) sts on right front, pick up and knit 3 sts in corner st, pm, pick up and knit 60 (62, 68, 72, 78, 84) sts along right front neck ending at right shoulder—345 (375, 399, 431, 463, 493) sts total. Place m and join (rnd begs at right back neck).

Rnd 1: [(P1f&b, p1) in same st] 0 (1, 0, 1, 1, 1) time, (p1f&b) 34 (34, 38, 38, 38, 40) times, (p1f&b, p1) in same st 0 (1, 0, 1, 1, 1) time, sl m, [p1f&b] 9 (9, 10, 11, 12, 13) times, (p1f&b, p1) in same st, [p1f&b] 40 (42, 46, 48, 52, 56) times, (p1f&b, p1) in same st, [p1f&b] 9 (9, 10, 11, 12, 13) times, sl m, [p1f&b] 8 (9, 9, 9, 10, 11) times, [(p1f&b, p1) in same st] 2 (2, 2, 3, 3, 2) times, [p1f&b] 8 (9, 9, 9, 10, 11) times, sl m, [(p1f&b, p1) in same st] 1 (1, 2, 1, 1, 1) time(s),

[(p1f&b, p1) in same st, p1f&b] 11 (12, 12, 14, 15, 16) times, (p1f&b, p1) in same st, [p1f&b, (p1f&b, p1) in same st] 11 (12, 12, 14, 15, 16) times, [(p1f&b, p1) in same st] 1 (1, 2, 1, 1, 1) time(s), sl m, [(p1f&b, p1) in same st] 6 (8, 8, 7, 8, 10) times, [(p1f&b) 2 times, (p1f&b, p1) in same st] 16 (19, 21, 24, 26, 27) times, [(p1f&b, p1) in same st] 6 (7, 7, 7, 8, 9) times, p1f&b, sl m, [(p1f&b, p1) in same st] 1 (1, 2, 1, 1, 1) time(s), [(p1f&b, p1) in same st, p1f&b] 11 (12, 12, 14, 15, 16) times, (p1f&b, p1) in same st, [p1f&b, (p1f&b, p1) in same st] 11 (12, 12, 14, 15, 16) times, [(p1f&b, p1) in same st] 1 (1, 2, 1, 1, 1) time(s), sl m, [p1f&b] 8 (9, 9, 9, 10, 12) times, [(p1f&b, p1) in same st] 2 (2, 2, 3, 3, 2) times, [p1f&b] 8 (9, 9, 9, 10, 11) times, sl m, [p1f&b] 9 (9, 10, 11, 12, 13) times, (p1f&b, p1) in same st, [p1f&b] 40 (42, 46, 48, 52, 56) times, (p1f&b, p1) in same st, [p1f&b] 9 (9, 10, 11, 12, 13) times—774 (846, 900, 972, 1044, 1110) sts total.

Rnd 2: *K3, p3; rep from *.

Rep Rnd 2 three more times, BO in pattern on last rnd. Sew button on left front to correspond with buttonhole. On left front, make a crochet chain (see Glossary, page 8) button loop on RS along inside edge of ruffle and sew button onto the inside of right front to correspond to loop. Weave in loose ends. ∞

Jill Wolcott lives in San Francisco, and despite the fact that her mother lives in Maui, doesn't get to Hawaii nearly as often as she'd like! Jill's pleased that her mother has been inspired by her designs and has taken up knitting again.

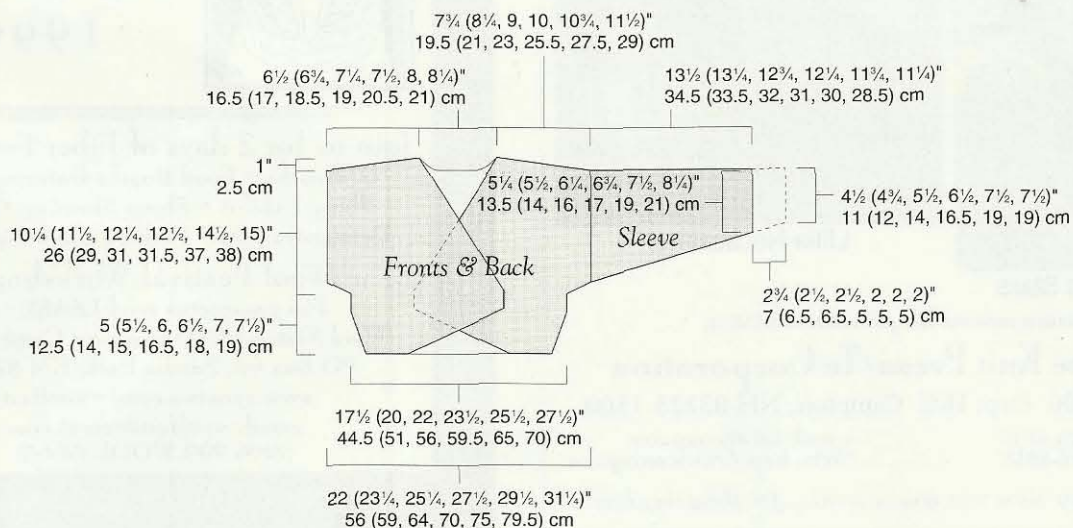

End the Buttonhole Blues

An incredible new hand knitting video reference from Leslye Solomon and special guest Dorothy T. Ratigan shows you how to become a buttonhole and cardigan band expert. 90 minutes of close-ups. A video you'll want to watch again and again.

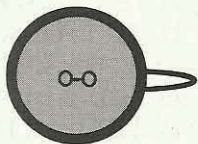
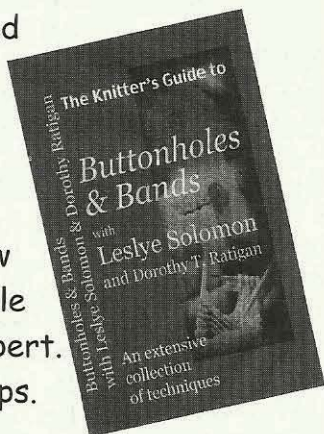

major credit cards accepted

**FiberFantasy
Knitting Products, Ltd.**

Department I
4848 Butler Road
Glyndon, MD 21071
800-242-5648

addi Turbo® needles the choice of professional knitters

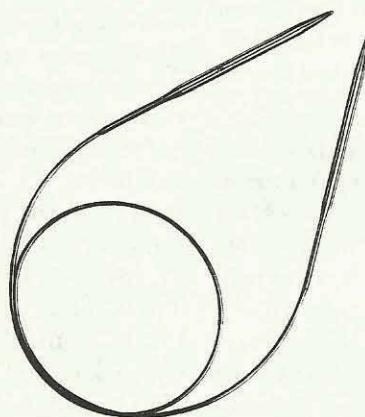

Slick tips, smooth joints and pliable cords have made the addi Turbo® circular needle the choice for professional knitters for years! Isn't it time you joined them?

Available in 8 lengths from 12" to 60" and in 19 sizes ranging from a US 000 to a US 36.

available in fine yarn shops

Exclusive Distributor

skacel collection, Inc.
PO Box 88110, Seattle, WA 98138-2110
Phone: (253) 854-2710
Fax: (253) 854-2571

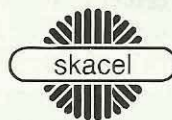

Hand Knit, Machine Knit, & Crochet Patterns for Living & 18 Dolls *

Many Different Books

* Popular dolls 18"-20" including American Girl® collection from Pleasant Co., 16"-18" bunnies and bears.

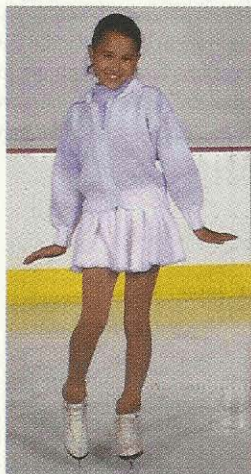

Skating Stars



Little Necessities

For detailed pattern information, please send a SASE to:

Close Knit Press/Te Corporation

POB 1500 Dept IKC Campton, NH 03223-1500

Voice: 603 726-4700
Fax: 603 726-8818

e-mail: dolls@tecorp.com
Web: <http://www.tecorp.com>

Patterns for those who love to create...for those they love ~

16th Annual WOOL FESTIVAL at Taos



OCTOBER
2 & 3,
1999

Join us for 2 days of Fiber Festivities
60 Booths • Food Booths featuring lamb
Sheep Exhibit • Sheep Shearing • Fiber
Demonstrations • Fashion Show • Auction

Wool Festival Workshops

For prospectus send LSASE to:

Wool Festival Workshops c/o Carol Mullen
PO Box 98, Sandia Park, NM 87047

www.zynetwc.com/~woolfest/

email: woolfest@zynet.com
(888) 909-WOOL (9665)

60 Booths • Demonstrations • Auction • Food Booths

Kit Carson Park • Taos, NM • (888) 909-9665 (WOOL) for info.

October 2 & 3, 1999 • 9am-5pm each day



UTE SOCKS

NANCY BUSH

*Contrasting cuff,
heel, and toe*

*Native American
patterning*

FINISHED SIZE To fit an adult woman's foot: 9½" (24 cm) long and 8½" (21.5 cm) around.

YARN Brown Sheep Nature Spun 3-ply Sport (100% wool; 184 yd [168 m]/50 g): #720 ash, #N40 grape harvest, #235 beet red, #N48 scarlet, 1 ball each.

NEEDLES Size 0 (2 mm): Set of 5 double-pointed (dpn). Adjust needle size if necessary to obtain the correct gauge.

NOTIONS Marker (m); tapestry needle.

GAUGE 18 sts and 22 rnds = 2" (5 cm) in pattern; 16 sts and 24 rnds = 2" (5 cm) in St st.

THESE SOCKS ARE INSPIRED by traditional Native American Ute beadwork designs. They are knitted from the cuff to the toe on double-pointed needles. The 2/2 ribbing in the cuff grades subtly from red to purple.

•**Leg:** With scarlet, CO 72 sts. Divide evenly onto 4 dpn. Place m and join, being careful not to twist sts. Work k2, p2 ribbing for 6 rnds. Join beet red and work 3 rnds *k2 beet, p2 scarlet; rep from *. With beet only, work 6 rnds in established rib. Join grape harvest and work 3 rnds *k2 grape, p2 beet; rep from *. With grape only, work 6 rnds in established rib. With ash, knit 3 rnds. Cont to end of Leg chart—piece should measure about 7¼" (18.5 cm) from beg.

•**Heel: Heel flap:** With grape, k18, turn. Sl 1, p35—36 heel sts (and 36 instep sts). Turn work and work heel sts only.

Row 1: *Sl 1, k1; rep from *.

Row 2: *Sl 1, p35; rep from *.

Rep Rows 1 and 2 for 36 rows total—18 chain sts at each edge.

Turn heel: (Work in short rows.)

Row 1: K20, ssk, k1.

Row 2: Sl 1, p5, p2tog, p1.

Row 3: Knit to 1 st from gap, ssk, k1.

Row 4: Sl 1, purl to 1 st from gap, p2tog, p1.

Rep Rows 3 and 4 until you have used up all the heel flap sts—20 sts rem. **Shape gusset:** With grape, k10 heel sts, with ash, knit rem heel sts. Cont with ash, pick up and knit 18 sts along right side of heel flap,



Brown Sheep Nature Spun
3-ply; 13 wraps per inch

k36 instep sts, pick up and knit 18 sts along left side of heel flap, k10 heel sts—92 sts. Arrange sts so that there are 28 sts on needle #1, 18 sts each on needles #2 and #3, and 28 sts on needle #4. Knit to 3 sts from end of needle #1, k2tog, k1. Knit across all sts on needles #2 and #3. On needle #4, k1, ssk, knit to end. (Note: Always keep the last 3 sts on needle #1 and the first 3 sts on needle #4 in ash on all rounds as you work the gusset shaping.) Beg Foot chart as foll:

Rnd 1: Needle #1: [K1 grape, k5 ash] 4 times, k3 ash. Needles #2 and #3 (36 sts): [K1 grape, k5 ash] 6 times. Needle #4: K3 ash, [k1 grape, k5 ash] 4 times.

Rnd 2: Needle #1: K1 beet, [k4 ash, k2 beet] 3 times, k4 ash, k1 beet, k2tog ash, k1 ash. Needles #2 and #3: K1 beet, [k4 ash, k2 beet] 5 times, k4 ash, k1 beet. Needle #4: K1 ash, ssk ash, k1 beet, [k4 ash, k2 beet] 3 times, k4 ash, k1 beet.

Rnd 3: Needle #1: [K1 scarlet, k5 ash] 4 times, end k2 ash. Needles #2 and #3: [K1 scarlet, k5 ash] 6 times. Needle #4: K2 ash [k1 scarlet, k5 ash] 4 times.

Rnd 4: Work with ash. Needle #1: Knit to last 3 sts, k2tog, k1. Needles #2 and #3: Knit. Needle #4: K1, ssk, knit to end.

Rnd 5: Knit with ash.

Rnd 6: Needle #1: K3 ash, [k1 grape, k5 ash] 3 times, k1 grape, k2tog ash, k1 ash. Needles #2 and #3: K3 ash, [k1 grape, k5 ash] 5 times, k1 grape, k2 ash. Needle #4: K1 ash, ssk ash, k1 ash, [k1 grape, k5 ash] 3 times, k1 grape, k2 ash.

Rnd 7: Needle #1: K2 ash, [k2 beet, k4 ash] 3 times, k2 beet, k2 ash. Needles #2 and #3: K2 ash, [k2 beet, k4 ash] 5 times, k2 beet, k2 ash. Needle #4: K2 ash, [k2 beet, k4 ash] 3 times, k2 beet, k2 ash.

Rnd 8: Needle #1: K3 ash, k1 scarlet, (k5 ash, k1 scarlet) 3 times, k2tog ash, k1 ash. Needles #2 and #3: K3 ash, [k1 scarlet, k5 ash] 5 times, k1 scarlet, k2 ash. Needle #4: K1 ash, ssk ash, k1 scarlet, [k5 ash, k1 scarlet] 3 times, k2 ash.

Rnd 9: Knit with ash.

Rnd 10: Rep Rnd 4.

Cont in this manner, keeping patt as established and dec at end of needle #1 and beg of needle #4 every other rnd until 18 sts rem on each back needle—72 sts total.

•**Foot:** Work even in patt until foot measures 2" (5 cm) less than desired total length.

•**Toe:** With grape harvest, knit 1 rnd.

Rnd 1: Needle #1: Knit to 3 sts from end, k2tog, k1. Needle #2: K1, ssk, knit to end. Needle #3: Knit to 3 sts from end, k2tog, k1. Needle #4: K1, ssk, knit to end.

Rnd 2: Knit.

Rep Rnds 1 and 2 until there are 9 sts on each needle—36 sts total. Then work Rnd 1 only until there are 2 sts on each needle—8 sts total. Break yarn and thread

tail through rem sts. Pull up snug and fasten off.

•**Finishing:** Weave in loose ends. Block under a damp towel or on a pair of sock blockers.

Nancy Bush lives in Utah, where she has seen amazing Native American art her whole life. She is the author of Folk Socks (Interweave Press, 1994) and enjoys pairing her interest in sock construction with design inspiration from both local and global sources.



Foot

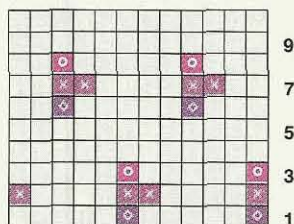

Leg

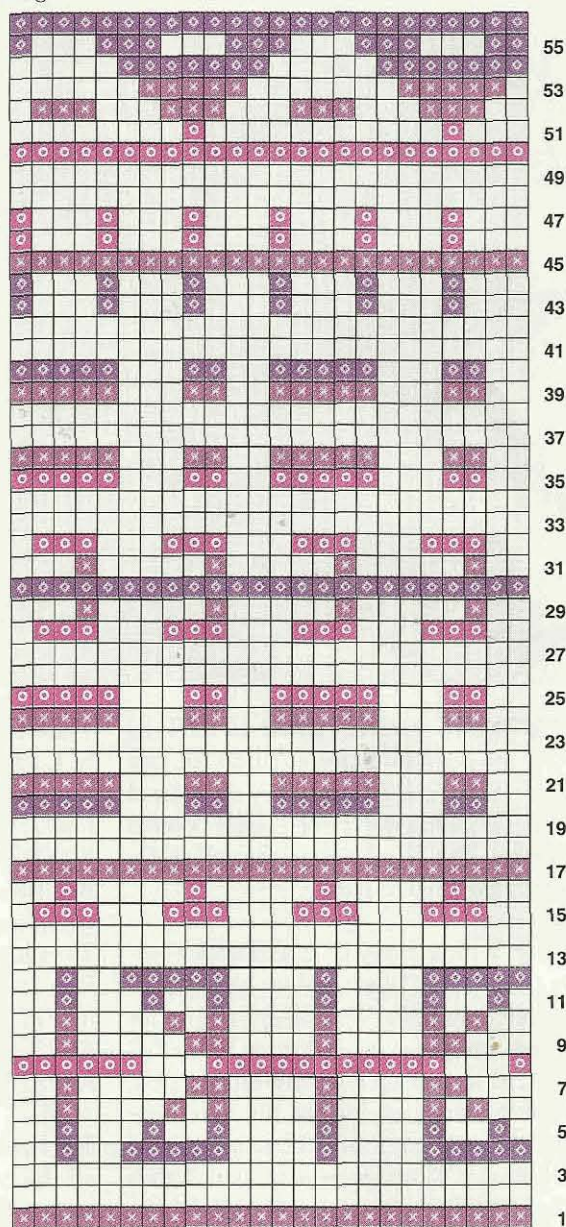

Knit Meg's Bavarian Twisted-Stitch Cardigan in firmly spun *Québécoise Wool*, which will show off the sculpted effect of this traditional stitch. You may choose from 18 different colors (for samples, see below), or go with the default color of grey as shown on page 44. Use the instructions given in this issue. Send \$66.ppd to receive sufficient wool for size 44" plus 5 pewter buttons.



Supplying Handknitters Since 1959
Please add \$5 for sample cards of 13 types of wool, including 160 J&S Shetland colors - plus a catalogue of books, videos, needles, buttons, tools, etc.

Schoolhouse Press
Pittsville, WI 54466

Order: 800-YOU-KNIT
Fax: 715-884-2829

Questions: 715-884-2799
visa/mastercard/discover

THE WOOL CONNECTION

New Releases

Hand Knitted Lace Video
by Nancie Wiseman

A Close Knit Family
by Melissa Leapman

Complete Idiots Guide to Knitting and Crocheting
(282 pages!)

Sweaters from New England Sheep Farms
by Candace Eisner Strick

Hats On!
by Charlene Schurch

We stock the yarns featured in this issue!
Order your kit today!
1-800-933-9665

Aztec Daisy Cardigan
Estonian Inspired Pocket Bag
Maghrib Vests
The Sanquhar
Hungarian Rhapsody
Irish Diamond Shawl
Aran Duffle Coat
Ute Socks
Petroglyph
Andhra Pradesh Vest

34 East Main Street, Avon, CT 06001
1-860-678-1710 • Fax 860-677-7039
<http://www.woolconnection.com> E-mail: wool@tiac.net

Order Our Catalog for \$3
refundable with your first purchase



Cottage Creations

A perfect baby gift ..

THE GRABBIT!
Knit a 36" square with loops and handle . . . it's magically either a blanket or a bag to tote all those baby things!

Pattern is \$6.00 ppd. Visa/Mastercard 515-324-1280
Or send LSASE for brochure of all eighteen patterns.

Cottage Creations
At the Farm on Deer Creek
Carpenter, IA 50426-0070

Nancie Knits Videos

P.O. Box 221777 • Sacramento, CA 95822
(916) 394-9104 • <http://www.nancieknits.com>
e-mail: nancieknits@earthlink.net

Add \$4.20 shipping and handling for each item ordered. CA res. add 7.75% tax.

NEW VIDEO

Hand Knitted Lace

Learn the basics for Hand Knitted Lace. Includes blocking and storage info.

1 hour and 20 minutes

\$40.00

Three Techniques for More Colorful Knitting

Slip Stitches, Intarsia & Fair Isle
Shown in Continental and American Styles of Knitting

1 hour 20 minutes **\$35.00**

Continental Knitting

All the information needed to learn this faster knitting technique. Closeups for easy viewing.

\$25.00

Double Pointed Needle Protectors

Small Covers
\$7.50

Large Covers
\$8.00



Wholesale
Inquiries
Welcome

CONNECTIONS

Katarina Lindell Voll



Knitting in the Fast Lane

VOGUE RAVES about her, VH1's *Fashion TV* has televised a profile of her, and Pepsi has used three of her dresses in a commercial. With her company Hulderknit and the fascination for Nordic mythology that influences her creations, designer Lise Solvang has taken the fashion world by storm. But this Norwegian knitter speaks modestly of her fast career as one of the new young designers in Los Angeles. She mentions in passing the *Fashion TV* story and the fact that she designed all the knitwear in Eduardo

Lucero's award-winning 1997 collection. What she prefers to speak of is the time when, as a struggling actress, she performed theater and told stories about Scandinavia and Nordic mythology for the children in South Central.

scious, very sensual. And because my entire collection is handknitted, it's only for those who can afford it." Goldie Hawn's daughter Kate Hudson and Sheree Wilson of television's *Walker, Texas Ranger* are among Solvang's many private clients. Angie Everhart, Christina Applegate, and Minnie Driver own Hulderknits as well. Even Madonna's daughter Lourdes is showing off a Solvang design. When Marla Maples posed for *In Style*, she was offered clothes by Richard Tyler and Gucci, but chose a long Hulderknit dress.

"She said she wanted to wear one of my designs at some future award show," gleams Solvang. She knows that a designer whose creations are worn by celebrities in public has it made. In Los Angeles, she says, that is the only way a designer can get ahead of the competition.

When she arrived in Los Angeles seven years ago, Solvang had no other plan than to become an actress. In Norway she had worked as a dancer on television and in theater performances. "I was the showgirl in the slinky costume," laughs Solvang. Because she also had experience as an actress, she decided to pursue the acting dream in Hollywood.

"I got myself a commercial agent, a theater agent, and

sexy head shots. I auditioned for a beer commercial in a bathing suit along with hundreds of others." She shakes her head and laughs at the procedure that scares or frustrates all newly arrived, serious actors.

"I was twenty-nine and had worked professionally in Norway for eight years. This," she says of the beer commercial and the entire Hollywood scene, "was not my cup of tea."

When the 1992 riots broke out in Los Angeles, Solvang broke out of Hollywood. The racial feud at first scared her to tears, then to action.

"I thought that something had to be done. I know I can't save the whole world—or even Los Angeles. But maybe I can sew seeds of tolerance for the sake of humanity. Maybe I can inspire children to become actors or dancers. And that could encourage them to leave South Central."

Along with a group of actors, Solvang began playing children's theater and telling tales of Nordic mythology for the

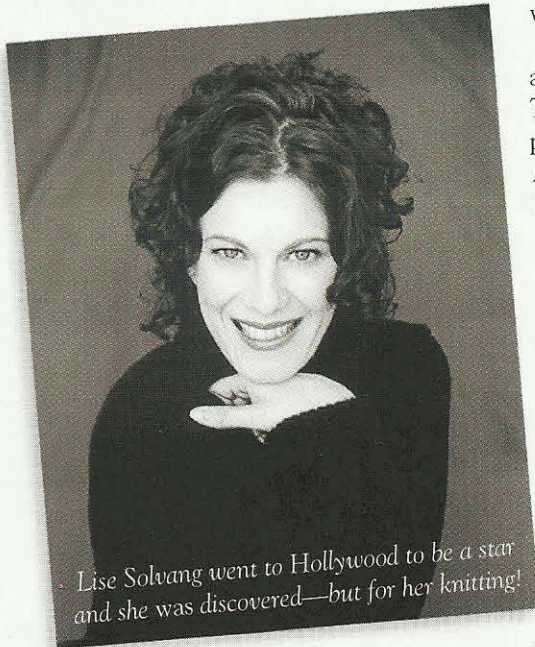

Lise Solvang went to Hollywood to be a star and she was discovered—but for her knitting!

Lucero's award-winning 1997 collection. What she prefers to speak of is the time when, as a struggling actress, she performed theater and told stories about Scandinavia and Nordic mythology for the children in South Central.

Solvang, 36, is not flamboyant and says that she has to be herself. Although her life today is distant from her upbringing on a farm in Norway, her earthy past is expressed strongly in both her personality and her knitted designs, which are inspired by ancient Nordic goddesses.

"Los Angeles is glamour, and that's the kind of clothes I make—very body con-

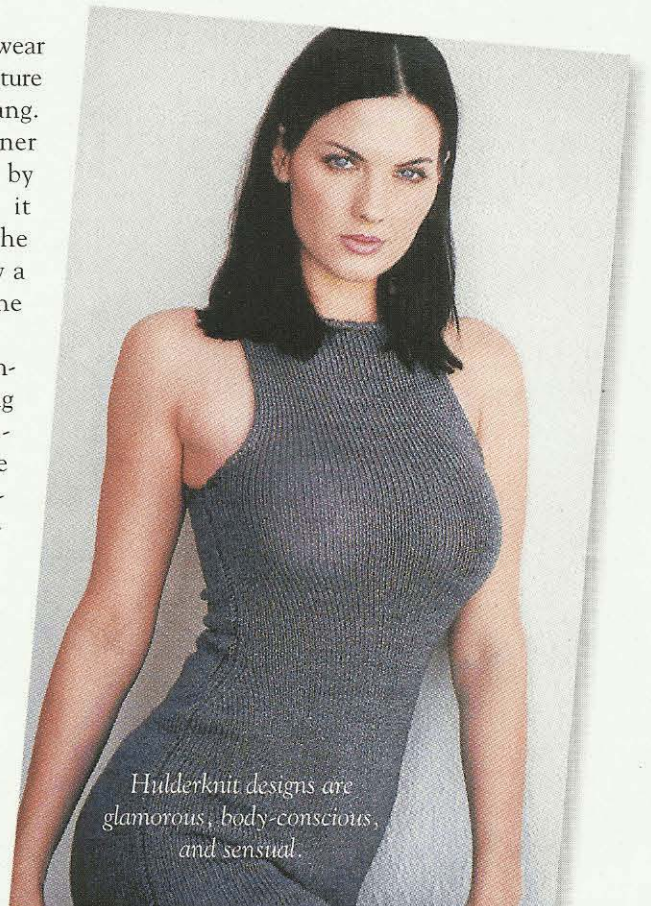

Hulderknit designs are glamorous, body-conscious, and sensual.

children living in the poorer areas of Los Angeles.

"I took them into fairyland and made them really see things: trolls and princesses. That teaches them how to use their creative minds. And it makes me happy to give something that is worthwhile."

To make her living, Solvang knitted and sold clothes to friends—until a shop owner saw one of her creations.

"She asked me to knit for her store. When she went to a trade show, she brought some samples of my knitwear."

There the press noticed the clothes, and soon *Vogue* called. "We would love to do a profile on you as one of the upcoming designers in LA," she echoes and adds, big-eyed, "Isn't that amazing?"

Once she created her company Hulderknit, named after a beautiful Nordic woman in a mythological tale, Solvang hired a sales representative and knitting contractors to keep up with all her orders. Since then, she says, she's been on a roll, knitting every waking hour—even while driving. "Ssh, don't say anything," she laughs.

By crocheting all her pieces together by hand, Solvang gives her knitwear a common signature.

"Crochets and knits are very popular right now, so I am riding on that wave," she explains.

While this Norwegian knitter looks forward to seeing Hulderknit grow in the United States, which is now her home, she also dreams of starting a second company in her native land.

"I think everything happens for a reason," Solvang says. "I chose to play children's theater rather than pursue acting, and that led me to where I am today." By successfully interweaving her love for knitting, Nordic mythology, and the children of South Central into one perfect pattern, Solvang has made a lasting achievement. ∞

Katarina Lindell Voll is a freelance writer living in Los Angeles.

Want to make your own Hulderknit? Call (818) 377-9555 for a brochure of knitting kits.



Lise Solvang and Sheree Wilson, star of Walker, Texas Ranger.



KNIT THOSE KITS

1-800-764-9276(YARN)

OPEN 7 DAYS A WEEK

ESTONIAN-INSPIRED POCKET BAG – \$18

MAGHRIB VESTS

GREEN VEST – 36"/40"/43"/47" – \$66 51"/54" – \$89

PURPLE VEST – 36"/40"/43"/47" – \$72 51"/54" – \$84

THE SANQUHAR – 37"/41" – \$39 46" – \$44 51" – \$56

HUNGARIAN RHAPSODY – 35"/38" – \$92 41" – \$103 44" – \$115 47" – \$120

IRISH DIAMOND SHAWL – \$19

ARAN DUFFLE COAT – 41"/44" – \$91 48"/51" – \$104

PETROGLYPH

MUENCH LA PLATA –

34" – \$76 38" – \$86 42"/46" – \$105 50" – \$114 54" – \$124

CHELSEA SILK –

34" – \$72 38" – \$78 42" – \$91 46" – \$98 50" – \$104 54" – \$117

ANDHRA PRADESH VEST – 38"/40" – \$52 42"/44" – \$58

SALE*SALE*SALE*SALE*SALE*

LANA D'ORO – CASCADE – 50% ALPACA 50% WOOL

50GM – 5 STS = 1" 110 YDS

#207 – RICH FOREST GREEN

#226 – DK FOREST GREEN

#203 – LIGHT BEIGE #221 – SLATE BLUE

#212 – DK RASPBERRY #206 MED. GREEN/TEAL

#211 – MEDIUM RASPBERRY

\$2.95/SKEIN

VISA - MASTERCARD - AMERICAN EXPRESS

Exquisitely Angora

by Rosalie Truong



**Specializing in
Handpainted
Yarns**

1222 Mackay Place • St. Louis, MO 63104

Email: truong@borcim.wustl.edu

Website: <http://www.angorayarn.com>

314-771-6302

Call or write for a FREE Pamphlet



Interweave Knits

BACK ISSUES

- Summer 1999** \$5.95
Classy Combos, Storage Ideas
- Spring 1999** \$5.95
Embellishment
- Winter 1998** \$5.95
Classics Revisited, Retro
- Fall 1998** \$5.95
Luxury Fibers, Finishing
- Summer 1998** \$5.95
Upsizing for the Fuller Figure
- Spring 1998** \$5.95
Creative Use of Color
- Winter 1997** \$5.95
Double Knitting, Accessories
- Fall 1996** (premier issue) \$5.95
Fair Isle, Entrelac

YES! Send me the *Interweave Knits* back issues checked above. Here's my check/ money order in U.S. funds for \$ _____ including s&h (see chart opposite). *Colorado residents add 3% sales tax.*

Shipping & Handling	
If order totals	Add
\$10.00 & under	\$2.95
\$10.01 to \$30.00	\$4.95
\$30.01 to \$50.00	\$6.95
\$50.01 to \$75.00	\$8.95
\$75.01 to \$100.00	\$9.95
\$100.01 & over	\$11.95

Charge my VISA MC AmEx Disc

Card # _____

Exp. date _____ Phone _____

Signature _____

Or for credit card orders, call 800-645-3675.

Ship to _____

Address _____

City/State/Zip _____



INTERWEAVE PRESS

201 E. Fourth St. Dept. A-KA Loveland, CO 80537-5655
800-645-3675; fax 970-667-8317 www.interweave.com

Woolen Yarns...

Pure wool yarns in a variety of weights and colors for knitting and weaving.

Carded wool in natural and dyed colors for handspinning and feltmaking.

Custom carding, spinning and dyeing available.

Send \$4.00 for knitting yarn samples.

Dealers inquiries invited.

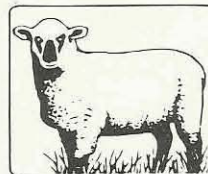

WILDE YARNS®

PO Box 4662, Dept. I
Philadelphia, PA 19127-0662
Spinning Wool Since 1880.

Heirloom Woven Labels

Box 428, Moorestown, NJ 08057 • <http://members.aol.com/heirloom>
Phone (609) 722-1618 • Fax (609) 722-8905

Circle style and/or motif

Style: A Motif: Q



Style: B Motif: K

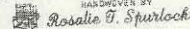

Style: G Motif: CP



Style: J Motif: JD



Style: T Motif: SN

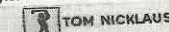

Style: E Script

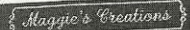

Style: R Block



ACTUAL SIZE 1/2" WIDE

MOTIFS											
Circle your choice. Not available with Style E or R.											
A	CX	JD	GE								
C	GN	JW	KS								
KM	KP	E	Z								NO MOTIF

CUSTOMER INFORMATION please print

Name _____

Street _____ Apt.# _____

City _____ State _____

Zip _____ Phone () _____

Enclose CHECK, MONEY ORDER, or VISA/MC/AMEX #: _____

expires _____

Signature _____

COLORS Circle one for lettering, one for background below.

LETTERING	LABEL BACKGROUND
Red, Gold Lurex on	White, Cream, Grey, Black, Green, Navy
Green, Goldenrod on	White, Cream, Black
White, Gold Lurex on	Grey, Rose, Sky, Lilac, Black, Green, Navy
Blue, Brown, Black, Pink on	White, Cream

LABEL INFORMATION please print

Line 1 _____

Line 2 _____

Please do not split up orders.

36 labels for \$21.00
72 labels for \$27.50
144 labels for \$40.00
NJ residents add
6% sales tax
Postage and handling \$2.95
Total \$ _____

Allow 3-4 weeks delivery.

IK999

FRENCH YARNS

FOR HANDKNITTING, MACHINE-KNITTING, & NEEDLEPOINT

JASMINE® SILK, PARISIAN COTTON®

BELANGOR® ANGORA,

KILHIM® EGYPTIAN COTTON,

MERINO KING®, ECOWOOL®

FLORE® KID MOHAIR,

KISMET® METALLIC,

CASHMERE & WOOL,

CASHMERE & SILK BLENDS.

SUPPLYING RETAIL STORES, DESIGNERS,

MANUFACTURERS & KIT MAKERS

FOR INFORMATION &/OR ALBUM PLEASE CALL

1-800-836-3314

Galler Yarns

JOSEPH GALLER YARNS, INC.

MONROE, NEW YORK 10950-9736





MONKEYSUITS® KITS

Monkeysuits kits and patterns are available mail order for selected styles. To place an order or to get a brochure, call or fax (718) 782-7529, or visit Monkeysuits online at www.monkeysuits.com. Individual Monkeysuits patterns are also available at yarn shops in the US and Canada. Call or write for a store near you.

At left: Checkered Past #5K. Check-stitch cardigan with matching hat. Kit includes yarn (Cascade Lana d'Oro wool/alpaca), buttons & pattern. 3-9 mos. - \$39, 1-2 yr - \$39 & 3-4 yr - \$44, plus shipping & handling. Visa, Mastercard and American Express accepted.

542 Lorimer Street #6, Brooklyn, Ny 11211

Tregellys Fibers

15 Dodge Branch Road
Hawley, MA 01339
(413) 625-9492 fax (413) 625-8144
email: fiber@javanet.com

www.tregellysfibers.com

AB Gunnar Anderssons
&
Glimåkra Looms & Equipment
Earthues™ Natural Dye Extracts,
Louet & Ashford
Spinning Wheels,
Brittany Needles,
Crystal Palace Bamboo
Round Needles,
Natural Kettle Dyed
Mohair Blended Knitting
& Weaving Yarns.
**Shades Natural Kettle
Dyeing Studio**
We will custom dye your yarn in
our 60 gallon kettles using
exclusively
Earthues™ natural dye extracts

the mannings Handweaving School & Supply Center



1132 Green Ridge Rd
PO Box 687

East Berlin, PA 17316

717-624-2223

ORDERS - 1-800-233-7166

We stock what every knitter needs: Knitting Books (189 titles), patterns from Ann Norling, Fiber Trends, Woolen collectibles, etc., yarns from Brown Sheep, JCA, Henry's Attic, Renaissance, Tahki, Plymouth, Skacel, etc., knitting needles, NEW wooden cable needles, and a large selection of the popular sock yarns. \$2.50 FOR CATALOG AND YARN STYLE CARD

DESIGN SOFTWARE

• **Garment Styler**
for knitting instructions & sewing patterns \$85.

• **Stitch Painter**
for gridded knit & craft design \$85/\$165.

Cochonille Design Studio
P.O. Box 234276 - C
Encinitas, CA 92023-4276
(619) 259-1698

Windows & Macintosh

catalogue \$1.
<http://www.cochonille.com>

Stripe Games

by Juliane Nollan
Anderson

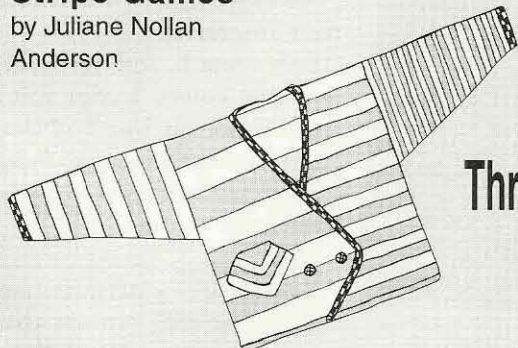

An easy to knit cardigan at 4 st=1" in a kit with 100% shetland wool, Sm-XXL, \$76-\$109. Brochure available for our kits, patterns. Luxury scarf kits in cashmere, exotic blends and handpainted yarns,

Threadbender Yarn Shop

2767 44th St SW
Grand Rapids, MI 49509
616-531-6641 or
888-531-6642 (for kit orders)
www.Threadbender.com

Cotton Yarn by Mail



Call Us Toll Free!

We'll put the cotton yarns you're looking for - and more - right into your hands. Our catalog has it all! Over 1500 colors of cotton and cotton blend yarns in hundreds of weights, sizes and textures. Unique knitting kits, books, patterns, videos and tools. All with quick delivery, friendly service and a 100% Satisfaction Guarantee! Save with our bulk discounts, introductory offers and weekly specials. Plus the \$5 cost of this catalog with yarn samples is refundable with your first order.

Mail to: **Cotton Clouds**
5176 South 14th Ave., Dept IK-99
Safford, AZ 85546-9252

Enclosed is \$6.50 (PPD) for catalog & samples



Name _____

Address _____

City _____

State _____

Zip _____

Credit Card Orders 800-322-7888

FOLKLORE

Robin Hansen



THREE BOYS between the ages of seven and ten look placidly out of the past into the camera, while other children, both boys and girls, crowd in behind them, trying to get their smiling faces into the frame. The photo is old enough that no one's fingers are making a V.

The three boys in front are wearing beautiful sweaters, knitted by their mothers or grandmothers, probably for their first day of school in Gøta, a small town in the Faroe Islands. Vibeke Lind uses this photo in her book, *Knit in the Nordic Tradition*—a book now scarce and almost forgotten on the European side of the Atlantic—to demonstrate the care and love put into sweaters for family members and to contrast their fine knitting with “the cheap sweaters knitted for export” she depicts on the facing page.

I took a copy of the photo with me to the Faroe Islands and showed it around, with other photos, for commentary. When

The Gøta photo: Talking to Hargarð Tvórfoss

I showed the photo to Óluva Húsgarð she exclaimed, “That photo’s from Gøta, where I grew up! I know those boys!”

Óluva actually recognized two of the three. The one on the left is Hargarð Tvórfoss (ð is silent, r is as in the

Midwest) who lives in Nordgota and works in Runavík; the boy on the right is Johannes Thomsen (“jo” is “yo”) of Norð Skála. All these places are on Estúroy, where Gøta also lies. I telephoned Hargarð at work and explained about the photo and my curiosity. Did he remember it being taken? Did he remember the sweater?

“Oh sure!” he said good-naturedly. “My grandmother knitted that sweater. She’d be over a hundred today if she were alive.”

Did he still have the sweater?

“Worn out and long gone!” he said.

“What about the colors?” I asked.

It was in Faroese colors, Hargarð said, with a light morrit (natural sheep’s red-brown) background, and a pattern in dark morrit, white, and black. Right now I’m putting together a pattern based on these colors and will send Hargarð a sample along with a copy of the photo.

To my astonishment, he’s never seen the photo and it’s well enough known in the Faroes to have a name. It’s also traveled abroad, probably around the world, in both Vibeke Lind’s book and an earlier tourist guide. It also figured prominently in my dissertation.

Hargarð who is sixty-two thinks he was “six or seven” in the photo. That would push its date back from 1950 to at least 1946 if not earlier, when the cash knitting of Faroe sweaters was peaking because of the foreign military presence during World War II.

To experience for yourself the neat interlaced patterns, the lovely warmth, and the beauty of Faroese colors, I offer you a three-color cap based on Hargarð’s sweater. Be sure to finish it with twelve gathers to thwart witchcraft. ∞

Robin Hansen is a folklorist and freelance writer and knitter with a passionate interest in traditional knitting.



REPRINTED WITH PERMISSION OF LILLIAN PETERSEN; ERIK PETERSEN, PHOTOGRAPHER.

A WORLD OF *Mittens*



Judith Durant

I went to *Enchanted Knitting* by Catherine Cartwright-Jones and Roy Jones (Interweave Press, 1997) in search of a color pattern. I was intrigued by an explanation of the indigo-colored robes worn by the men of the Tuareg tribe in North Africa—because there is little water or wood available for dyeing, they pound the indigo directly into the cloth, making it a shiny midnight blue. I had just the right blue yarn in my stash, and I coupled it with some Plymouth Galway (100% wool; 230 yd [210 m]/100g) in natural on size 3 (3.25 mm) needles.

Ann Budd

I've been working on Nancy Bush's upcoming book, *Folk Knitting in Estonia*, and am fascinated by the decorative cuffs on mittens and gloves from this part of Europe. Wanting mittens with a decidedly ethnic look, I "borrowed" the fringe stitch, vikkel braid, and lace stitch used in the Estonian Pocket Bag project on page 31. Now if I could only find my way to the Baltics, I'd fit right in! I used Harrisville Designs Highland Style (100% wool; 200 yd [183 m]/100 g) in garnet on size 4 (3.5 mm) needles.



Marilyn Murphy

One of my favorite stops during Interweave Press's *Scandinavian Journey* is the charming little museum on the second floor of a handcraft shop in Leksand, Sweden. These mittens were inspired by a pair from their collection. The original pair was a small gauge so I had to modify the stitch pattern to make it fit the back of the hand.

I used Fishermen's Wool from Lion Brand Yarn (100% wool; 465 yd [425 m]/8 oz) and size 2 (2.75 mm) needles.



Amy Clarke

As to why I have one mitten rather than two, honesty is the best policy in cases of neglected knitting. I've been obsessed with beadwork lately and couldn't tear myself away from my latest bead project to begin the second mitten. I used Brown Sheep Worsted Weight (85% wool, 15% mohair; 190 yd [174 m]/100 g) in gold glow and deep red on size 2 (2.75 mm) needles.

Nancy Disney

I started out knowing I wanted to use black yarn from my stash. I bought some teal to match my parka plus red and yellow for contrast. All are Brown Sheep Lamb's Pride (85% wool, 15% mohair; 190 yd [174 m]/100 g). I decided to modify the Andean design from Marcia Lewandowski's *Folk Mittens* (Interweave Press, 1997) for the color pattern. When I knit my gauge swatch I realized that the black yarn was bulky, not worsted, so I had to go down to size 1 (2.25 mm) needles to achieve gauge. I like the resulting tight, heavy knitted background for these mountaineering mittens. I knitted the left mitten, then switched the color order on the right mitten just to see what it would look like. A bonus is that it's easy to tell left from right when I pull them from my pack. Next I'll knit myself a hat.



Susan Strawn Bailey

My mittens mimic the free-form design and sunset colors of a natural-dyed-hemp crochet (I think) bag sent to me from Ecuador. My son Chris and his fiancée Andrea bought the bag in an artisan market in Quito, and gave it to me to indulge, as they put it, my "interest in material culture."

I chose eight clear, intense colors of Dale of Norway's Heilo (100% wool; 100 m [91 yd]/50 g) and followed the basic pattern. Looking to the Ecuadorian bag for color inspiration, I combined colors that I hadn't thought would coexist so happily.



Jennifer Nastu

Okay, so I was feeling less than creative this time around. I followed the mitten pattern exactly, but I added two garter stitch rows just for kicks. Then I embroidered flowers with fire-engine red silk that I spun myself. I have to say that, despite my lack of inspiration, I'm thrilled with the result. This is the first pair of mittens (or mitten, I should say—can you tell from the photo there's only one?) that has actually fit! All my other mittens made me look like I had muppet hands. Not necessarily bad, but still, I like having mittens that stay on my hands, rather than sliding off into a snowbank. Now, if only I can finish the other one before winter arrives.

BASIC MITTEN INSTRUCTIONS

(Adapted from Folk Mittens by Marcia Lewandowski, 1997, Interweave Press)

FINISHED SIZE About 8¼" (21 cm) around by 8¼" (21 cm) long, excluding cuff.

YARN Worsted-weight wool: 4 oz (100 g).

NEEDLES Size 2 (2.75 mm): Set of 4 double-pointed (dpm). Adjust needle size if necessary to obtain the correct gauge.

NOTIONS Markers (m); short length of contrasting yarn; tapestry needle.

GAUGE 12 sts = 2" (5 cm).

Left mitten:

Cuff: CO 48 sts onto 1 dpm. Arrange sts evenly onto 3 dpm. Join, being careful not to twist sts. Work k2, p2 ribbing for 2" (5 cm), or desired length, inc 2 sts evenly spaced on last rnd—50 sts.

Hand: Change to St st (knit every rnd) and work 1 rnd even. **Thumb gore:** Work across 22 sts, pm, M1, k1, M1, pm, work to end of rnd—52 sts. Work 1 rnd even. On next rnd, *work to first m, sl m, M1, work to next m, M1, sl m, work to end. Work 1 rnd even. Rep from * 7 times total—17 thumb sts bet ms; 67 sts total. On next rnd, work to first m, remove m and place 17 thumb sts onto length of contrasting yarn, remove second m, using the backward loop method (see Glossary, page 7), CO 1 st over held thumb sts, rejoin, and work to end—50 sts. Cont on 50 sts until piece measures to middle of little fingernail. **Dec for top:** Arrange sts as follows: 25 palm sts on needle #1, 12 back-of-hand sts on needle #2, 13 back-of-hand sts on needle #3.

Rnd 1: K1, ssk, work to 3 sts from end of needle #1, k2tog, k1; k1, ssk, work to end of needle #2; work to 3 sts from end of needle #3, k2tog, k1.

Rnd 2: Work even.

Work these 2 rnds 4 times total—34 sts rem; 17 sts on needle #1, 8 sts on needle #2, 9 sts on needle #3. Then rep Rnd 1 only until 10 sts rem—5 sts on needle #1, 2 sts on needle #2, 3 sts on needle #3. Break off yarn leaving a 6" (15-cm) tail. Thread tail onto tapestry needle, draw through rem sts, pull tight, and fasten off. **Thumb:** Place 17 held thumb sts onto dpm as follows: 6 sts on needle #1, 6 sts on needle #2, 5 sts on needle #3. With needle #3, pick up and knit 3 sts in gap, and join—20 sts. Work in the rnd until piece measures

—continued on page 86



The Good Shepherd
Luscious hand-dyed yarn you will love to work with!

Carolyn W. Partridge
RFD Box 192 Old Cheney Rd
Windham, Vermont 05359
802-874-4182

Sample Cards \$7.50

From Our Farm In New Hampshire Beautiful, Elegant, Superfine Merino

Yarns, Knitting Kits and More
Free Catalog or please visit our
website at www.StagnerFarm.com

For our sample yarn card,
please send \$3.00.

*NOTE: Yarn shops are
invited to inquire about
a wholesale relationship.*



Fine Woolens
BY
STAGNER FARM

RR1 Box 78, Langdon, NH 03602
603-835-6673 Email: jstag@sover.net



HAND-DYED YARNS
ANGORA, MOHAIR, LLAMA & SHETLAND

We raise our own Angora rabbits, Angora goats, llamas and Shetland sheep which we use in our blends.

Angora/Merino/Silk • Angora/Polworth Wool
Kid Mohair • Llama/Angora • Llama/Kid Mohair
Kid Mohair/Merino/Silk

Happy J Farms
P.O. Box 214, Dept. I • Beasley, TX 77417
(409) 387-2521 • <http://www.happyjfarm.com>



The Button Box

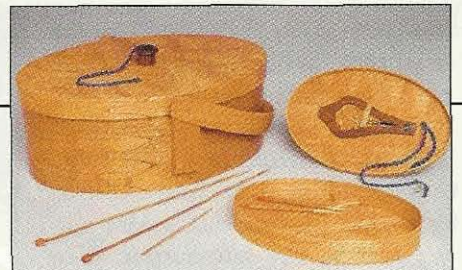

The Knitting Companion

Goods from the Woods

Treat yourself to tools as fine as your work.

HC 1 Box 19 Onchiota NY 12989 www.gftw.com email: goodwood@northnet.org 800-338-6111

PRODUCT NEWS

Judith L. Swartz

The Complete Idiot's Guide To Knitting and Crocheting

Gail Diven and Cindy Kitchel
Alpha Books • \$16.95

The Complete Idiot's Guide To Knitting and Crocheting by Gail Diven and Cindy Kitchel packs an amazing amount of information into its chapters. The basic information is presented in a humorous and user-friendly style, enhanced with many sidebars encoded as pointers, snarls, needle talk, and yarn spinning. This book is an excellent beginner's guide as well as a good reference for the experienced knitter. I'm just not sure how my customers will respond when I put it in their hands and say "This book is perfect for you!"

Available at your local yarn shop or bookstore.

A Close-Knit Family:

Sweaters for Everyone You Love

Melissa Leapman
Taunton Press • \$24.95

Melissa Leapman's first book *A Close-Knit Family: Sweaters for Everyone You Love* will appeal to knitters of all skill levels. The designs are well-thought-out and not just large and small versions of the same design—these contemporary classics are appropriately geared to age and

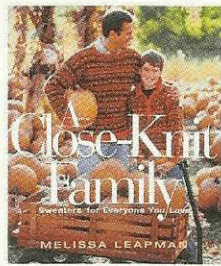

gender. They span a range of fiber types and weights and so are suitable for a variety of seasons and climates. These are sweaters you will knit and wear for years to come.

Available from your local yarn shop or Taunton Press, (800) 477-8727.

Hand Knitted Lace Video

Nancie Wiseman
Wisewater Productions • \$40.00

If you want to learn to knit lace, Nancie Wiseman's *Hand Knitted Lace* video is a must. Intended as a companion to her

recent book *Lace from the Attic: A Victorian Notebook of Knitted Lace Patterns* (Interweave Press, 1998), this

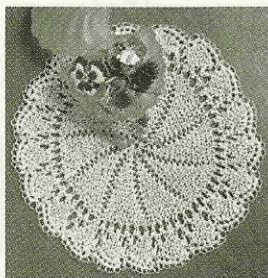

video is like sitting down with Nancie in her studio for a two-hour private lesson. She covers every aspect of lace knitting (including correcting mistakes) in a logical progression, usually using oversized tools for even further clarity. Best of all, there is no need to ask her to repeat something—you just rewind.

Available from Knitwise, PO Box 221777, Sacramento, CA 95822.

Abby's Basket

Elizabeth Kurr • \$3.50–\$4.00

Abby's Basket is a collection of pattern leaflets for knitting and crochet designed by Elizabeth Kurr. The collection focuses



on accessories and the designs are relatively easy to produce. Sized from infant to adult, this self-published series has clearly written and presented instructions that are good for sampling circular knitting or simple crochet.

Available through your local retailer, or contact Abby's Basket, 2521 S. Euclid, Berwyn, IL 60402 for a retailer near you.

Mountain Colors Hand-Dyed Yarns

\$18–\$32 per skein

Mountain Colors has added four fabulous new fibers to their collection of hand-dyed yarns. Wooly Feathers is a very aptly named novelty, a bulky weight mohair/nylon blend peluche. Mountain Goat is a lustrous two-ply mohair/wool blend. Merino Ribbon knits up with a wonderful texture and none of the slippery handling usually associated with ribbon. Then there's the 100 percent superfine cabled cashmere. With five new colorways added this season, the combinations of color and texture in these yarns is exquisite.

Available at your local yarn shop or contact Mountain Colors, PO Box 156, Corvallis, MT 59828, (406) 777-3377 for a retailer near you.

Stitch Keepers

Enabling Technologies • \$6.00 per set

What a practical, sensible invention these double-pointed needle stitch keepers are. These rubber tips joined by a



length of elastic not only keep your stitches from falling off the ends of double-pointed needles, they also keep the set of needles together. Why didn't I think of this?

Available through Enabling Technologies, 1198 Gatestone Cir., Webster, NY 14580, e-mail abkowitz@ibm.net.

Northwest Angora Yarns and Kits

Kits \$11–\$24

Yarn \$12 per 2-ounce skein

Northwest Angora is a very small, Oregon-based cottage business that focuses on quality and luxurious U.S.-produced angora-blend yarns. They also



offer kits featuring their products (a lace scarf kit is pictured). Other kits offer socks, mittens, gloves, and a variety of

hats. The yarns are soft and lustrous—blended beautifully with silk or merino and spun with a handspun appearance, this is hardly the fluffy stuff we usually think of as angora.

Available through Northwest Angora, 35455 S.E. Crescent Rd., Boring, OR, 97009, e-mail beedlebuns@aol.com.

Judith Swartz, manager of the Weaving Workshop in Chicago and a knitwear designer, has an ideal sounding board for new knitting products—her customers.

To order books in this magazine, or any book in print, call (800) BOOKS-NOW (226-5766) or (801) 261-1187, 24 hours a day. Ask for ext. 1668. Or visit us on the web at <http://www.Booksnow.com/interweaveknits.htm>.

continued from page 84

to middle of thumbnail. **Dec for top:**

Rnd 1: [K5, k2tog] 2 times, k4, k2tog—
17 sts rem.

Rnds 2, 4, and 6: Work even.

Rnd 3: [K4, k2tog] 2 times, k3, k2tog—
14 sts.

Rnd 5: [K3, k2tog] 2 times, k2, k2tog—
11 sts.

Rnd 7: [K2, k2tog] 2 times, k1, k2tog—
8 sts.

Work 1 rnd even. Break off yarn leaving a 6" (15-cm) tail. Thread tail onto tapestry needle, draw through rem sts, pull tight, and fasten off. Weave in loose ends. Block.

Right mitten: CO and work as for left mitten to thumb gore. **Thumb gore:** Work across 27 sts, pm, M1, k1, M1, pm, work to end. Cont as for left mitten. ∞

Subscribers to Interweave Knits receive all the pattern variations used by the staff in Knits News, a twice-yearly newsletter published in January and September. If you don't subscribe to Interweave Knits and wish to receive the staff patterns, send a #10 SASE to Mittens, Interweave Knits, 201 E. Fourth St., Loveland, CO 80537-5655.

SOURCES FOR SUPPLIES

(W) = Wholesale (R) = Retail

YARNS

Yarns used in this issue are available through your local retail store or mail-order company. If you are unable to locate the supplies, below is a listing of the U.S. distributors. Write to them for a retail source.

- (W) Alice Starnore, Unicorn Books & Crafts, 1338 Ross St, Petaluma, CA 94954-6502.
- (W) Berroco Inc, 14 Elmdale Rd, PO Box 367, Uxbridge, MA 01569.
- (W) Brown Sheep Company, 100662 County Rd 16, Mitchell, NE 69357.
- (W) Dale of Norway, N16 W23390 Stoneridge Dr, Ste A, Waukesha, WI 53188.
- (W) Harrisville Designs, Box 806 Center Village, Harrisville, NH 03450.
- (W) JCA, Inc/Reynolds, 35 Scales Ln, Townsend, MA 01469-1094.
- (W) Muench Yarns/GGH, 118 Ricardo Rd, Mill Valley, CA 94941-2461.
- (W) Plymouth Yarn/Cleckheaton, PO Box 28, Bristol, PA 19007.
- (W & R) Schoolhouse Press, 6899 Cary Bluff, Pittsville, WI 54466.
- (W) Tahki Yarns/Austermann, 11 Graphic Pl, Moonachie, NJ 07074.
- (W) Westminster Fibers/Rowan Yarns, 5 Northern Blvd, Amherst, NH 03031.





Yarn Kits-to-Knit Finished Items	100% LLAMA yarn 75 yds/approx. 50g 18 colors \$9.95 ppd	
	100% LLAMA plied with British Mohair yarn 55 yds/approx. 50g 14 Colors \$8.95 ppd	
STONE FOX FIBRE WORKS 1544 East River Rd. Grafton, Wisconsin 53024 (414) 375-2719 stonefox@execpc.com www.stonefoxllamas.com		catalog with knittable samples \$5 refundable with order
Soft, Warm, Wonderful LLAMA		



FIBER KINGDOM

luxury fibers and colors to delight your senses

FROM THE NORTH COUNTRY OF NEW YORK STATE

-  Unique natural fiber yarns hand-dyed in harmonious color palettes
-  Original design kits
-  Special buttons, dyes, books, Addi Turbo needles
-  Luxury fibers and equipment for spinners, weavers, felters
-  Workshops, personalized instruction

SEND LSASE FOR PRODUCT INFORMATION TO:
SYLVIA GRAHAM, FIBER KINGDOM BOX 654 EAST BROADWAY SALEM, N.Y. 12865
518 854 7225 PHONE/FAX fibrking@sover.net Email: fiberking@sover.net

WE'RE SERIOUS ABOUT YARN

GREAT DISCOUNTS * UNMATCHED SERVICE
NAME BRAND YARNS * WEBS' EXCLUSIVE YARNS
TERRIFIC CLOSEOUTS

See why thousands of knitters have been buying natural fiber yarns from Webs for over twenty years

Introductory samples \$2.00

Tell us you saw our ad in *Interweave Knits*



WEBS, America's Yarn Store, P.O. Box 147,
Service Center Rd., Northampton, MA 01061-0147
413/584-2225 Fax: 413/584-1603
Visit our web site at <http://www.yarn.com> or e-mail webs@yarn.com
Store & Warehouse open Mon.-Sat. 10 am to 5:30 pm

New!

T · H · E
Lily Chin
C · O · L · L · E · C · T · I · O · N

To see the full line, visit our web site @ www.fibertrends.com

Then ask for Fiber Trends Patterns at Your Favorite Yarn Store

Retailers, for wholesale information contact:
Bryson Distributing @ 1-800-544-8992
or Fiber Trends @ 1-888-733-5991

Fiber Trends • P.O. Box 2634 • Bellingham, WA 98227-2634



103LC 'Charlotte's Easy Lace Shawl'
The easiest lace shawl you will ever knit!

KOIGU WOOL DESIGNS
Handpainted **KOIGU WOOL DESIGNS**
 KOIGU PAINTERS' PALETTE PREMIUM MERINO
 PATTERN BOOKS - CATALOGUE
PHONE: (519) 794-3066 - koigu@hotmail.com
 RETAIL - WHOLESALE

CLASSIC SWEATER KITS AND YARNS
 Featuring Yarns from New England/Canada, Norway & Iceland, Authentic Guernsey wool from England, Jo Sharp Yarns & Books, Rowan Kits & Yarns, Shetland and Aran Yarns
IN THIS ISSUE (ALL PRICES PPD)

Aztec Daisy Cardigan	78.00/82.00/87.00	Aran Duffle Coat	77.00/77.00/88.00/88.00
Estonian-Inspired Pocket Bag	15.00	Ute Socks	8.00
Maghrib Vest (Green)		Petroglyph (Muench)	
	55.00/55.00/55.00/55.00/75.00/75.00		64.00/72.00/88.00/88.00/96.00/104.00
Maghrib Vest (Purple)		Petroglyph (Tahki)	
	60.00/60.00/60.00/60.00/70.00/70.00		60.00/66.00/77.00/82.00/88.00/99.00
The Sanquhar	33.00/33.00/38.00/48.00	Andhra Pradesh Vest	44.00/44.00/48.00/48.00
Hungarian Rhapsody			
	87.00/87.00/98.00/110.00/115.00		

Visit us on the World Wide Web at www.barkim.com or e-mail your order to barkimtd@aol.com

BARKIM LTD.
 47 West Polk St., Suite 100-303, Chicago, IL 60605
 Toll Free Orders! 888/548-2211 FAX 773/624-3380

VISA/MC AMEX/DISC

Easy shopping on the Internet!
 Advanced searching capabilities, featuring yarns, fibers, tools, spinning wheels, looms, kits, patterns, and books for:
 Knitting and Crocheting
 Needlepoint, Lace and Embroidery
 Spinning
 Weaving
 Free shipping on most orders over \$20.00!!

www.redmeadow.com
 e-mail: info@redmeadow.com

★ PERSONAL SERVICE ★ EXPERT FINISHING ★

AYLIN'S WOOLGATHERER
1-800-775-WOOL
 GREAT SELECTION OF EXQUISITE YARNS FROM ALL OVER THE WORLD. HUNDREDS OF BUTTONS.
 AREA'S LARGEST COLLECTION OF PATTERN BOOKS.
 ROSEWOOD & EBONY, ADDI, AND CLOVER NEEDLES.
 Look us up on Internet: <http://www.aylins-wool.com>
 Email: aylin@aylins-wool.com

AYLIN'S
 7245 ARLINGTON BLVD., FALLS CHURCH, VA 22042 • (703) 573-1900
 Ask for our brochures

INSTRUCTIONS INSTRUCTIONS

★ EXPERT FINISHING ★ PERSONAL SERVICE ★

• DALE • ROWAN • JAEGER •
 REYNOLDS • JO SHARP • SIRDAR • NORO • VITTIDINI • MANOS • TAHKI • MISSONI •
Infant & Toddler Guernsey
 LANE BORGOSIESIA • SKACEL • BROWN SHEEP • MUENCH

DESIGN BY Louise™ \$4.00 per pattern
 Pattern #22

"The most complete yarn & needlework shop in S.E. New England"

SAKONNET PURLS
 3988 Main Road
 Tiverton, RI 02878

www.sakonnetpurls.com
 Phone: (Toll Free) 888-624-9902

Quick and Easy to Knit!

Elise Duvetot's
 Salt and Pepper Sweater in
 Lustrous Wensleydale Yarns
 Kits: S(\$92), M(\$101), L(\$110),
 XL(\$119); Pattern only: \$7 ppd

Beth Brown-Reinsel
Knitting TRADITIONS
 P.O. Box 421-IF • Delta, PA 17314
 tel: (717) 456-7950 • fax (717) 456-3751
KnitTradit@aol.com
<http://members.aol.com/KnitTradit>

The Knits Resource Guide

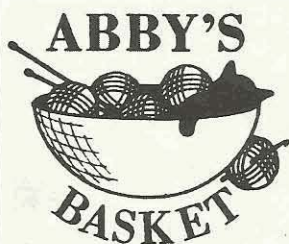

ABBY'S

BASKET

*Knitting & Crochet
Patterns, etc.*

Patterns available at Patternworks

Introducing a fun new line of knitting and crochet patterns. For product and price information call, write, or visit Abby's Basket online at <http://www.abbysbasket.com>

ELIZABETH KURR

2521 South Euclid
Berwyn, IL 60402
(708) 788-8342

Cheryl Oberle Designs

Hand-painted Knitting Kits for
Sweaters, Vests, Shawls and Socks

3315 Newton St
Denver, CO 80211

oberleknits@worldnet.att.net
303-433-9205

Color Samples
and Brochure \$10
(Refundable with Order)

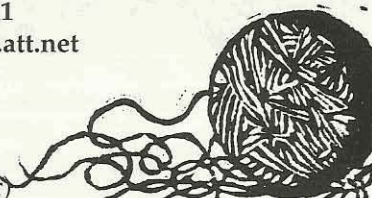

Bette Bornside Company

Yarns and knitting supplies since 1986

Free shipping on orders over \$30
1-800-221-9276 VISA/Mastercard

Berroco, Brown Sheep, Cleckheaton, Classic Elite,
Ironstone, Lion, MacAuslan, Plymouth, Reynolds,
Renaissance, Rowan, Tahki, Trendsetter, Unger, Vittadini

Call or write for list of shade cards.

2733 Dauphine St., Desk WK, New Orleans, LA 70117



**Blackberry Ridge
Woolen Mill, Inc.**

Wonderfully Soft Yarns from our Mill
More new sock and lace shawl
patterns, kits, and yarns

Free catalog listing yarns and kits
Yarn samples \$3.00
3776 Forshaug Road Mt. Horeb, WI 53572
(608) 437-3762

Visit our web site at:
www.blackberry-ridge.com



PURE WOOL
Since 1821

100% WOOL YARNS

Blues, laurels, roses & greens—79 warm colors—heathers, all-naturals, solids, marls, tweeds. Lanolin-rich, pure wool. Ideal for classic sweaters, cozy caps & mittens. Thrifty 4-oz skeins. Ask us for dealer names & FREE color packs.

Bartlettyarns, Inc.

Box 36-KF9 Harmony ME 04942 207/683-2251

Pamper Yourself...

Luxurious AMERICAN CASHMERE
from herds all across America

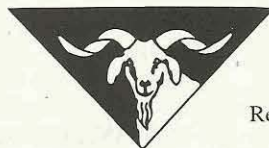

100% CASHMERE Yarn
CASHMERE Blend Yarns
Ready-To-Spin CASHMERE Fiber

To order, call/write:
CASHMERE AMERICA COOPERATIVE

P.O. Box 1126, Sonora, TX 76950,
(915) 387-6052 (Tu or Th)
or a Dir. at (360) 424-7935 (WA), or (207) 336-2948 (ME)

Shuttles, Spindles & Skeins, Inc.

*knitting • spinning • yarn
weaving • basketry
classes • equipment*



Judy Steinkoenig
Maggie Putnam

633 South Broadway #2N
Boulder, CO 80303

Table Mesa Shopping Center
1-800-283-4163 303-494-1071

Hours: Mon. 12 Noon-6 pm; Tue.-Sat. 10 am-6 pm; Closed Sundays

Garment
Shaping

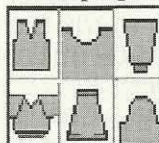

Design Layout



DesignaKnit

For Hand and Machine Knitters



<http://www.knitcraft.com>

Stitch
Designer

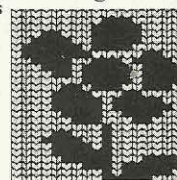

Knitcraft Inc.

500 N Dodgion
Independence Mo 64050
816-461-1217

The Knits Resource Guide

awesome ewe

Your Online Knitting Superstore

Cleckheaton - Colinette - Filatura Di Crosa
Gedifra - Jaeger - Katia - Rowan - Sirdar - Stahl

Call NOW For Your
FREE CATALOGUE

TOLL FREE **1-877-288-6558** TOLL FREE

www.awesomeewe.com

Stonehill Custom Spun Yarn, Patterns, & Fibers To Make Exquisite and Unique Projects

- The Finest In Commercial Yarns...
- Local Texas fibers—Llama, Mohair, Wool
- Custom spun in Texas—to our specifications
- Cotton & Linen yarns
- Exclusive Stonehill Patterns and Gifts

Stonehill Spinning, Ltd.

104 A East Ufer St.
Fredericksburg, TX 78624
830-990-8952
www.stonehillspin.com



Mountain Spinnery - Noro - Stahl - Sch...
efer - Classic Elite - Dale of Norway - Mountain Colors - GGH - Brown
Sheep - Lorna's Lace - Berocco - Tren...
Sitter - Sirdar - Plymouth - Tahki - Cascade - Patons - Hayfield - Green

IN SHEEP'S CLOTHING

Yarns & Fiber

Knitting
Crochet
Weaving
Spinning

Patterns
Books
Supplies
Classes

Mail Order Available



219 E Street, Suite D, Davis, CA 95616
(877) 759-9279 or (530) 759-9276
<http://www.insheepscloting.com>



HANDSPUN YARN NATURALLY DYED

Rainbow skeins
set of seven colors - 20 yd each skein
100% WOOL \$12 worsted weight
ANGORA/WOOL \$19 50/50 blend
worsted or sport weight

YARN SAMPLES &
BROCHURE \$4

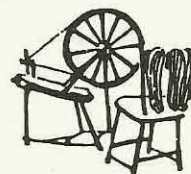

JAMIE HARMON 175 Barber Farm Rd
Box K Jericho, VT 05465

Gemini Fibres
is your Canadian retail source for all your Knitting Supplies
* best book selection—all the latest titles *
* Videos to rent or purchase *

- * Fibre Trend Patterns, Knitting Bracelets, McMorran Yarn Balance *
- * Ontario's Dealer for Harrisville Designs Yarn *
- * Hand-painted Unspun Scarf Kits & Hand-dyed Yarns *
- * Canadian & Norwegian Pewter * Brittany Knitting Needles *

We also carry a full line of weaving and spinning supplies.
MAIL ORDERS WELCOME / PRICE LIST with SASE

Gemini Fibres
5062 Mount Albert Road East
Mount Albert, ON L0G 1M0 Toll Free: 1-800-564-9665
Tel: 905-473-1033 / Fax: 905-473-6544



Kid 'N Ewe (and llamas too!)

Central Texas Wool Market
Blanco County Fairgrounds
Johnson City, Texas
November 12th, 13th and 14th

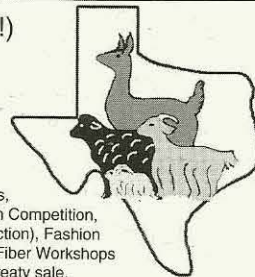

Spinning, Weaving, Knitting, Felting, Shearing Demos,
Llama events, Fiber-To-Fashion and Handspun Skein Competition,
Auction, Lamb Dinner (with alternate vegetarian selection), Fashion
Show, Dealers, Dog Trialing Demos and Workshop, Fiber Workshops
and all kinds of Livestock on display and for private Treaty sale.

For more information and tickets to the Dinner/Fashion Show please contact:
Mary Carol Buchholz, 6800 Creek Road, Dripping Springs, TX 78620
Ph 512-858-7920 or Tara Wheeler at 512-365-WOOL

NATURAL FIBER YARNS

including ROWAN, TAHKI, VITTADINI,
ELITE, REYNOLDS, PHILDAR, etc.

Plus first-quality mill ends

Send \$5.25 for complete mail order sample card of over
500 colors and textures

Periodic Updates • Quantity Discounts

Also Available: Exotic fiber sample card, approx. 150 samples of silks,
angoras, ribbons & exotics. \$2.75

Bare Hill Studios/Fiber Loft (retail)

Box 327, Rt. 111 (P.O. Bldg), Harvard MA 01451 • 1-800-874-YARN



Wool Pak • Koigu • Noro Yarns

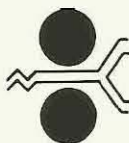

Susan's Fiber Shop

N 250 HWY. A
COLUMBUS, WI 53925
Ph (920) 623-4237 Fax (920) 623-0120
Orders: (888) 603-4237
e-mail: susanfiber@internetwis.com

- Socks From The Toe-Up Kit \$10
- Wool Mix—Natural Eucalyptus
- Nailbinding Books I & II & Needle \$6 each
- Nailbinding Mitten Book \$16
- Knitting Gilleys \$10
- Shipping \$4 first two items; then \$1 each additional item

Meg Swanson's Icelandic

Schachemayer Sock Yarn

Mountain Colors • Douceur de Soie

The Knits Resource Guide

TREENWAY SILKS SILKS FOR KNITTERS

74 GLORIOUS HUES RIBBONS AND YARNS

SAMPLES AND PRICE LIST \$10

725 CALEDONIA AVE
VICTORIA, BC CANADA
V8T 1E4

TEL (250) 383-1661 FAX (250) 383-0543
To order call 1 888 383-SILK
email: treenway@coastnet.com

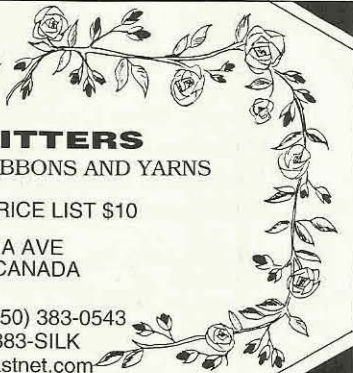

Qiviut

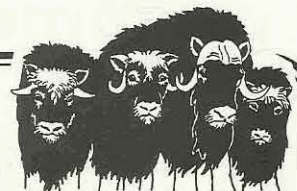

MOCO YARNS
fine yarns and fashions

The world's most exceptional rare fiber.

Wholesale inquiries only

633 Fish Hatchery Road Hamilton, MT 59840
Phone/Fax (406) 363-6287 E-mail: muskox@bitterroot.net

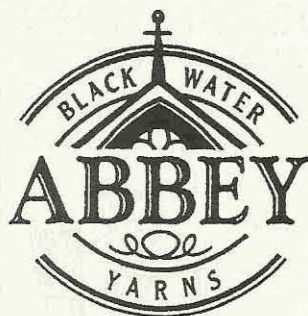

2-ply Traditional Irish Wool
Affordably priced in 4 oz. skeins
14 Beautiful Colors
for more information
contact:

Black Water Abbey Yarns
2222 S. Albion St., Suite 222
Denver, CO 80222
303-758-1047
e-mail: bwa@mho.net

Colorcards available for \$3.00, Refundable with Order

The Fiber Studio

New Hampshire's Leading Fiber Arts Store

- ◆ Looms ◆ Spinning Wheels ◆ Large assortment of fibers to spin & felt ◆ Natural fiber knitting & weaving yarns ◆ Hand-painted rayon chenilles
- ◆ Bamboo & wood needles ◆ Unusual beads & buttons

Yarn Samples \$5.00/set

Spinning Fiber Samples \$4.00/set Catalog \$1.00



9 Foster Hill Rd. PO Box 637. Henniker, NH 03242
603-428-7830 Open Tues-Sat. 10-4 Sun by Chance
www.fiberstudio.com e-mail: sales@fiberstudio.com

WOOL YARN

76 colors

2-ply, 4-oz skeins

Sport 1-lb cones

Bulky



FREE SAMPLES

1-888-608-3885 MC/VISA

e-mail <info@hvsheepandwool.com>

Visit our web site www.hvsheepandwool.com

SPINNER'S HEARTH



7512 LACKEY ROAD
VAUGHN, WA 98394
(253) 884-1500

ALL YOUR FAVORITE
YARNS, BOOKS, PATTERNS,
& SUPPLIES

- ALICE STARMORE -
- BROWN SHEEP -
- DALE OF NORWAY -
- CLASSIC ELITE - KOIGU -
- MANOS - MTN. COLORS -
- PATONS - REYNOLDS -
- PLYMOUTH -

VISIT OUR WEB PAGE:

<http://www.onmy.com/spinnersearth>
E-Mail: Spinhearth@aol.com

Knit with our soft wool yarn!

Over 60 Heather Tones, Tweeds, and Vibrant Shetland colors.

Worsted, sportweight, and bulky. In 4-oz skeins.

Affordable Price! Order directly from the farm producing fine wool fleece of Corriedale sheep.

Yarn samples \$3.

Refundable with order
MasterCard/VISA

1186 Jarvis Branch Rd.
Mars Hill, NC 28754
828-689-9931

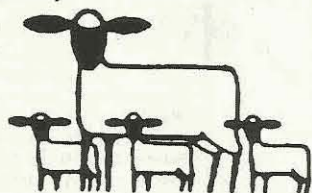

BOVIDAE FARM

Hanne Falkenberg • Swedish Yarns • A. Vittadini • Jo Sharp

Great Yarns

1208 Ridge Road
Raleigh, NC 27607
919-832-3599

e-mail greatyarn@gte.net

VISIT OUR NEW WEB SITE FOR INFORMATION ABOUT SPECIALTY AND UNUSUAL YARNS FROM AROUND THE WORLD.

www.great-yarns.com

Order Line 1-800-810-0045

Schaefer • Classic Elite • Reynolds • Dale • K1C2 • Trendsetter • Prism • Mt. Colors

Berocco • Colinette • *

The Knits Resource Guide

SWITZER LAND ALPACAS

ALPACA babies
ALPACA books
ALPACA hats
ALPACA jackets
ALPACA scarves
ALPACA shawls
ALPACA sweaters
ALPACA wool
ALPACA YARNS



Visit
Farm & Studio

• Books, Equipment, Looms & Wheels • Yarn Samples \$2.00 + SASE
Chris Switzer • Box 3800 • Mary's Lake Road • Estes Park, CO 80517
(970) 586-4624



Some call it string
I call it sanity

Trendsetters, Brown Sheep, Berroco,
Dale of Norway, Classic Elite,
Plymouth and more

All yarn 10 to 20% off retail prices

Catalog \$2.00 US refundable
with first order

<http://www.piecesofstring.net>
email: jeffslaby@piecesofstring.net

810 22nd Ave. S Moorhead, MN 56560 218-233-6670



Purveyor of Fine Knitting Materials

Your source for K1 C2 Gourmet Yarn,
Jo Sharpe Collection,
Rowan and Trendsetter yarns
Order Line **888•37•PURLS**

7862 N. Oracle Road
Tucson, AZ 85704-6315
520.797.8118

7810 E. Speedway Blvd.
Tucson, AZ 85710
520.296.6363

The Elegant Ewe

New England's newest and most exclusive source for the fiber artist.



The Elegant Ewe

71 South Main Street
Concord, NH 03301
603.226.0066
elegantu@worldpath.net

DESIGNER YARNS

Alice Starmore ~ Berroco
Classic Elite ~ Jo Sharp ~ Garnstudio
K1C2 ~ Colinette ~ Hanne Falkenberg ~
Trendsetter ~ Rowan ~ Dale of Norway ~
Muench ~ Harrisville ~ Green Mountain ~
Manos ~ Schaefer Yarns ~ Koigu

SPINNING-RUG HOOKING SUPPLIES
CLASSES, BOOKS, VIDEO RENTALS.
Local handcrafted gifts and Celtic Music.

Carolina Homespun is pleased to invite you to a
Premiere . . . to knock your socks off!!!

SOCKS
for Sandals and Clogs
Anna Zilboorg 1999

A collection of 11 stunning socks presented on a POSTER suitable for framing and accompanied by a BOOK of instructions and charts.
Wholesale inquiries invited

\$18.95 for the set + \$3.20 shipping
190 Eastridge Rd, Ridgeway VA 24148
Info: (540) 957-1174
Orders: (800) 450-7766
Homespun@kimbanet.com
www.kimbanet.com/~homespun

SOFT WOOL YARN

Merino-Rambouillet fine grade wool
Worsted & Sport weight
Natural & Dyed colors
Skeins & Cones

3 colors **100% CHEMICAL FREE**

New Zealand
Knitting Needles
SP pr. 2 thru 11
DP swt/4-2 thru 8
\$4.75 pair or set
plus \$4 shipping



Send Long SASE for free brochure and color samples to:

MARR HAVEN
772 - 39TH ST., DEPT IK ALLEGAN, MI 49010
(616) 673-8800 • <http://www.accn.org/~mh yarn>

• Trendsetter • Berroco • Tahki • Classic Elite • Prism •

Lorna's Laces • **Stahl** • **Plymouth** • **K1C2**

Sweater kits from Finland

Yarns By Design

247 E. Wisconsin Ave., Neenah, WI 54956
(920) 727-0530 E-mail: yarns@juno.com

Toll Free 1-888-55-YARNS

Visit our Web site:
www.yarnsbydesign.com

Located in historic Victorian home
across from Neenah Harbor—
Mon, Tues, Wed, Fri, Sat 10-5 • Thurs 10-8

Alice Starmore • Dale of Norway • Sirdar • Brown Sheep



SCHOOL PRODUCTS CO., INC.

Come look us over for
**The Widest Selection of Designer
Yarns Anywhere!**

Looms, Brother Knitting Machines,
Accessories, Books, Videos and More!

Big Selection-Big Discounts

Mail Orders Available

e-mail: berta@schoolproducts.com <http://www.schoolproducts.com>

1201 Broadway, New York, NY 10001 212-679-3516

The Knits Resource Guide



Genuine Purl

140 N. Market Street
Chattanooga, Tennessee 37405

"The knitter's jewel of the South"

You have got to see us to believe us! We have a great selection along with friendly service and expert advice. We ship daily.

Call the "Purl Girls"!

1-800-862-2890



cherry tree hill yarn

handpainted yarns for the fiber fanatic in us all!
terrific textures unforgettable colors

p.o. box 254
east montpelier
vermont 05651

(802) 229-0831
www.cherryarn.com

email: orders@cherryarn.com

Check out our website for free downloadable patterns, yarn, kits, accessories, and samples of all yarns and colorcards. Or send \$5 for new sampler, brochure, newsletter and kit list.

SpinCraft the handspinner's craft patterns

Box 327, Salmon, ID 83467

! FREE CATALOG !

We take Credit Cards 10am-6pm

(208) 756-3076

www.spindling.com

spincraft@spindling.com

Patterns for any yarn "Knit so it Fits"

Make it your size.

It's easy: Take a measurement, find your gauge, add it up, follow the directions. YOU are the designer!

Start with these collections: \$12.50 ea

• Best Vests • Best Sweaters • Best Hats

Accomplish even more—subscribe to

• SpinCraft Pattern Newsletter \$12

NEW BOOK: **Spindle Spinning: From Novice to Expert**

• By Connie Delaney: \$12 + 3 s&h (autographed copy!)



NOTICE TO CANADIAN RETAILERS:

Gemini Fibres Distributes Interweave Press, Schoolhouse Press, XRX Inc., and Taunton Press Books; Brittany Knitting Needles; Priscilla Gibson Robert's "NEW" book - "High Whorling", and much more.

BUY CANADIAN!

- NO CUSTOMS CHARGES OR DELAYS
 - FAST PERSONAL SERVICE
- Call today - Save Time and Money!



Gemini Fibres
5062 Mount Albert Road East
Mount Albert, ON L0G 1M0 Toll Free: 1-800-564-9665
Tel: 905-473-1033 / Fax: 905-473-6544



Nordic Fiber Arts



FLEECE LINED MITTENS

New!

Everyone LOVES them!!

Red, Black, Gray, Natural, Plum, or Green

\$29.00 ppd Visa & MC

4 Cutts Road Durham, NH 03824

603-868-1196

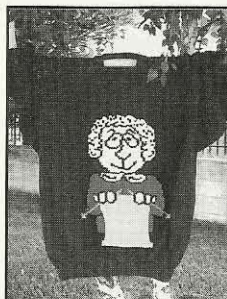

Introducing the New and Unique

"Crumpet and Tea Collection"

You'll love Mrs. Crumpet and her sheep, Tea! There's nothing like this duo! You'll be stopped on the street every time you wear your sweater!

Send \$2.00 for Brochure

Refundable with Order

Arky Arky Creations P.O. Box 21207 Bakersfield, CA 93390-1207



ALPINE REINDEER HAT
Adult only, 3 colors
\$27.50 ppd.



KITTENS & MICE HAT
Child only, 2 colors
\$17.00 ppd.



PUPPY BONES HAT
Adult & Child, 2 colors
\$22.00 ppd.

Kits are 100% Wool - Call for a free catalog - Many other kits

(800) 489-4969

Three Kittens Yarn Shoppe

805 Sibley Memorial Hwy., St. Paul, MN 55118

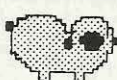

General Bailey Homestead Farm

Featuring top quality products at reasonable prices.

Announcing our new website: www.generalbaileyfarm.com

SPINNING WHEELS: Majacraft, Jensen, Schacht, Ashford, Louet, and Columbine Needles • Buttons • Books
Patterns • Yarn • Jewelry • Dyes • Exotics

Try our new super-size 13 3/4" x 18"

Knitter's Graph Paper—20 sheets \$8.50 ppd. • Catalog \$2.00

340 Spier Falls Road • Greenfield Center, NY 12833-2005

(518) 893-2015 Phone • (518) 893-0778 Fax

VISA • MASTERCARD • DISCOVER

INTRODUCING SKASKA'S MILLENNIUM WORKSHOP SERIES 2000

"So much more than a knitting workshop...prepare yourself for a truly inspirational cultural experience"

Learn to knit lace the unique Orenburg way...from Galina Khmeleva, author of GOSSAMER WEBS

S
K
A
S
K
A

NEW FROM SKASKA:

- triangle shawl workshop
- heavy (warm) shawl workshop
- the perfect edge-knitted lace embellishments
- skaska workshop plus-w/dinner & a movie
- knit & stay fit-w/tension intervention

COMING SOON:

- Orenburg West-stay & play with us in Colorado
 - Surface design workshop-create your own silk scarf and cotton tablecloth
 - Recipe of the month
- As always, a selection of museum quality, handknit Orenburg gossamer lace shawls and scarves
- authentic handspun Orenburg down
 - handcarved Russian support spindles

FOR COMPLETE DETAILS:

Visit our website:www.skaska.com
email:lacemail@skaska.com
phone/fax:(970) 224-5117

Classic Comfort For Today and Tomorrow

Designs By
Karen
Connor

Available
Through Your
Favorite
Knitting Retailer

*Many To
Choose From*



Woolgathering Designs

Karen Connor
Woolgathering Designs
7536 Forsyth, Box 345-SK
St. Louis, MO 63105



twelve unique collections of *wearable art*

See more of our inspired knitwear at www.icelandicdesign.com

or call/write for our 32 page color catalog US\$4. (refundable with purchase).

IceLandic Design 473 Main Street Suite 100 Longmont, Colorado 80501
303-651-3334 800-750-9299 fax 303-651-6611 info@icelandicdesign.com



CLASSIFIEDS

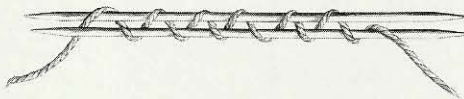

NOTICES

TO PLACE A CLASSIFIED AD for an upcoming issue, send your ad with payment by the following deadline dates: Spring issue, Jan. 5; Summer issue, March 23; Fall issue, June 15; Winter issue, Sept. 21. **Only \$2.50 per word (\$50 minimum). Payment must accompany ad.** Visa, MC, AMEX, Discover accepted with account number and expiration date. Send to **Interweave Press, KNITS Classified Ads**, 201 East Fourth Street, Loveland, CO 80537-5655, fax (970) 613-4664, or e-mail: SharonA@Interweave.com

SOUTHEASTERN ANIMAL FIBER FAIR (SAFF) October 30–31, 1999, WNC Agricultural Center in beautiful Asheville, NC. Animal competition, handspun and dyed yarns, knitting equipment and patterns, your favorite vendors, workshops, demos, kids activities, and crafts. Visit our web site at www.main.nc.us/saff or **Carolyn Blalock**, Rt 2 Box 42A, Horse Shoe, NC 28742. (828) 891-2810. E-mail: blalock@ioa.com

INSTRUCTION

KAFFE FASSETT & BRANDON MABLY from Kaffe Design Studio will be at the **Interlaken School of Art** for workshops in November, 1999. Kaffe will lead an innovative quilting workshop. Brandon will guide participants in an exciting two-day knitting seminar. Call for free catalog: (413) 298-5252; or write PO Box 1400, Stockbridge, MA 01262. e-mail: makeart@bcn.net

TIERRA WOOLS SCHOOL of Rio Grande Weaving Traditions offers beginning, basic tapestry, commercial dye classes, plus room with continental breakfast. In the mountains of northern New Mexico. Come join us for a wonderful learning experience. Information packets: **Tierra Wools**, PO Box 229, Los Ojos, NM 87551.

Toll free (888) 709-0979. <http://www.handweavers.com>

TRULY LEARN TAPESTRY WEAVING'S BASIC TECHNIQUES. Colorado mountain retreat. Great food! Accommodations, yarns, looms, included. Brochure: **Great Divide Weaving School**, KA, Box 100, Divide, CO 80814. (719) 687-3249.

WHIDBEY ISLAND WORKSHOPS: Kathryn Alexander, October 22–24, 1999; Nancie Wiseman and Laura Bryant, March 31–April 2, 2000; more! **Coupeville Arts Center**, Box 171-KN, Coupeville, WA 98239. (360) 678-3396; cac@whidbey.net; www.coupevillearts.org

KITS

KITS FEATURING LUXURIOUS ANGORA, MERINO & SILK YARN! The ultimate in warmth and luxury. Create exquisite and unique knitting garments. Small projects our specialty. Hats, scarves, socks, gloves, booties, and more. Send LSASE and \$2 for yarn samples and catalog to: **Beedle's Northwest Angora**, 35455 S.E. Crescent Rd., Boring, OR 97009, or e-mail: beedlebuns@aol.com for more information.

SWEATER KITS, NOVELTY KITS, and fine knitting yarns. Mail order catalog and shade card \$3.00. P O Box 323, Battle Lake, Minnesota 56515. VISA/MC. (218) 864-0094. Pneedles@prtel.com

LITERATURE

A KNITTER'S JOURNAL. Record your knitting information in 5½" x 8½" book. Section for projects, sizes, inventory, and more. **Special Offer:** Free needle holder with orders of two or more! Send \$16.98 each to: **Puddle's End**, PO Box 606, Bridgeport, NY 13030.

HUGE SELECTION NEW & OUT-OF-PRINT knitting & other needlework books. Information on free catalogs & newsletter: **Ruth Kern Books**, P O Box 35366, Phoenix, AZ 85069. Free book searches. Rkern@primenet.com <http://www.needlearts.com> (800) 429-5075. Fax (602) 944-1753.

JEAN GREENHOWE DESIGNS KNITTED DOLL BOOKS. Every book in stock. Please call for nearest stockist. **Prince Imports**, P O Box 1443, Roseville, CA 95678. Phone (916) 786-4859, Fax (916) 782-3610. e-mail: spectrum@inreach.com Dealer inquiries invited.

KNITTING NEWS—QUARTERLY NEWSLETTER. Reviews, hints, symbols, what's new, etc. Dealer for Addi needles. \$15/year includes 10% discount on books, yarn, and accessories. Box 1612-I, Carolina Beach, NC 28428. Visit our web site: www.craftassoc.com/knitting.html. e-mail: country@isaac.net

KNITTING PATTERNS FOR 11½" fashion, 18" girl, other dolls. Send SASE for listing. **Roper**, PO Box 34922, Richmond, VA 23234.

MACHINE KNITTERS SOURCE MAGAZINE, the place to turn for patterns, technical articles and designers profiles. Sample: \$2.00, subscription \$26.95 for 1 yr/6 issues. **MKS**, 3415 Custer Road, Suite 140, Plano, TX 75023. (800) 628-8047.

SOFTWARE

ORGANIZATIONAL SOFTWARE FOR KNITTERS & CROCHETERS. Catalog and categorize your patterns, books, and magazines. Inventory yarns and notions; over 70 companies listed! *Personal Diary* section, Needles Information and Conversions. Windows 3.1X & above. Contact your Local Shop or **LNS Software Solutions**, (253) 850-2457; or check our web site: www.lns-software.com

SUPPLIES

EARTHSONG FIBERS. Catalogue \$2.00; with quarterly newsletter \$5.00. 5115 Excelsior Blvd., #428, Dept. IK, Minneapolis, MN 55416. (612) 926-1201, (888) 473-5350. <http://www.earthsongfibers.com>

FINALLY!!! ODORLESS MOTH-PROOFING! Moth Guard mixes with water, is totally colorless and odorless. No insecticides or petroleum. Free tips to rid your home of moths included. One quart treats nine sweaters. 32 oz spray bottle \$15 ppd. **Moth Guard**, Box 423, Jenks, OK 74037. (888) 433-6684.

WEB SITES TO VISIT

WWW.BECREATIVEBOOKS.COM Newest books, patterns & kits for embroidery, knitting, crochet, quilting, sewing, crafts, and more. Discount prices. Frequent updates. Drawing for free gift. Visit the **BeCreative Bookstore**.

WWW.BFREE.ON.CA/VMALL/GRYARNS Great selection of kits, yarn, books for hand or machine knitters. **Grand River Yarns**, Canada. email: gyarns@bfree.on.ca

WWW.DMV.COM/~ICELAND Louise Heite, Importer. We supply genuine Icelandic unspun knitting yarn, books, lace knitting yarn and spindles. PO Box 53, Camden, DE 19934; ehaute@dmv.com; (800) 777-9665.

WWW.DOVETAILDESIGNS.COM Knit and crochet patterns, books and kits designed by Val Love, *Pocket Pals*, sweaters, hats, afghans, etc. **FREE CATALOG!**

WWW.PARADISEFIBERS.COM Come see our yarns, patterns, needles, books, bargains! **Paradise Fibers**, 701 Parvin Road, Colfax, WA 99111. (888) 320-SPIN; email: spinning@colfax.com Free Catalog!

WWW.SAWYERBROOK.COM Hand crafted garments deserve Unique buttons. View our *buttons* online or request our *best match* service. **Sawyer Brook Distinctive Fabrics**.

WWW.SOPHIESYARN.COM Yarn, patterns, kits, closeouts, our exclusive designs. Complete list of classes at our Philadelphia shop. **Sophie's Yarns**, (215) 977-YARN.

WWW.SWEATERSCAPES.COM includes free online instruction and landscape pattern

to help you get started on your adventure in intarsia knitting.

WWW.VELONA.COM "The yarn junkie's paradise". Serving the handcraft artisans worldwide for 23 years! **Velona Needlecraft**, e-mail: info@velona.com

YARNS

AFFORDABLE HANDSPUN YARN. Softly spun Alpaca, Merino & Mohair. Brochure w/samples \$3. **Arcata Bay Llamas**, PO Box 412, Arcata, CA 95518. Visit us at Arcata Farmers Market April–November; e-mail: handspiner@aol.com

FENLLEW FARM PRAIRIE WOOL AND MOHAIR YARNS. 26 colours in four weights. Coloured rovings. Kits. \$5 and SAE for colour catalogue and samples to: Box 578, Carman, MB, Canada R0G 0J0. VISA/MC accepted. **Wholesale Inquiries Welcome.** Phone/fax (204) 828-3624.

"HAND KNITS FOR HUNTERS" PATTERNS. Blaze/camo wools. Retail inquiries welcome. Shade cards \$3.00, re-

fundable with \$20.00 order. **Ellen Kellaway**, P O Box 20171, Belleville, ON, Canada K8N 5V1. e-mail: knithunt@kos.net

ICELANDIC SHEEP. Raw fleece, roving available. Soft, lustrous, wonderful! *Custom spinning available.* **Rainbow Ranch**, 4331 Garden Spot Rd., Clayton, WA 99110. (509) 233-2283. E-mail: rainbow.ranch@mindspring.com

LLAMA AND ALPACA YARN, mill-spun, 2-ply natural colors and blends. Send \$3 for sample card, refunded with order. **Rocky Mountain Lama Fiber Pool**, (970) 484-6241; 2933 E. Mulberry, Ft. Collins, CO 80524.

LUXURIOUS DESIGNER HAND-KNITTING YARNS. Competitive prices, exotic textures, exciting colors. **FREE** introductory package to production knitters. **Erdal Yarns, Ltd.** 303 Fifth Ave. Suite 1104, New York, NY 10016. (800) 237-6594; (212) 725-0162; fax (212) 252-0082; web site—<http://www.erdal.com>. e-mail: erdal@idt.net

ADVERTISERS' INDEX

3 Trails Handknit Designs . . . 57	Genuine Purl 92	Pieces of String 91
Abby's Basket 88	Good Shepherd, The 84	Plymouth Yarn Company . . . 28
Amazing Threads 21	Goods From The Woods . . . 84	Purls 91
Arky Arky 92	Grand View Country Store . . 67	Ram Wools 57
Aurora Yarns 53	Great Yarns 90	Red Meadow Fiber Arts 87
Awesome Ewe 89	Halcyon Yarn 35	Rovings 3
Aylin's Woolgatherer 87	Haneke Wool Fashions 63	Sakonnet Purls 87
Baabajoes Wool Co. 24	Happy J Farms 84	School Products 91
Bare Hill Studios 89	Harmon, Jamie 89	Schoolhouse Press 75
Barkim 87	Harrisville Designs 21	Sealed With A Kiss 43
Bartlett yarns, Inc. 88	Heirloom Woven Labels 78	Shuttles, Spindles & Skeins . . 88
Berroco 35	Hudson Valley	Skacel Collection 72
Bette Bornside Co. 88	Sheep & Wool Co. 90	Skaska Designs 93
Black Water Abbey Yarns . . . 90	Icelandic Design 93	Spincraft Pattern
Blackberry Ridge	In Sheep's Clothing 89	Newsletter 92
Woolen Mill 88	Interweave Press . . . 5, 12, 49, 78	Spinner's Hearth 90
Blue Heron Yarns 63	Joseph Galler, Inc. 78	Stagner Farm 84
Bovidae Farm 90	Kid 'N Ewe 89	Stone Fox Fibre Works 86
Brittany Company 29	Knitcraft, Inc. 88	Stonehill Spinning, Ltd. 89
Brown Sheep Company ifc	Knitting Traditions 87	Susan's Fiber Shop 89
Carolina Homespun 91	Koigu Wool Designs 87	Switzer, Chris 91
Cashmere America Co-op . . . 88	LaLana Wools 29	Tahki Yarns 25
Cherry Tree Hill Yarn 92	Lambspun of Colorado 53	Taos Wool Festival 72
Close Knit Press 72	Lampen, Betty 48	Threadbender Yarn Shop . . . 79
Coats Patons bc	Lion Brand Yarn Co. 35	Three Kittens Yarn Shoppe . . 92
Cottage Creations 75	Lorna's Lace 13	Tierra Wools 8
Cochenille Design Studio . . . 79	Louet Sales 29	Treenway Silks 90
Cotton Clouds 79	Mannings, The 79	Tregelley Fibers 79
Crystal Palace Yarns 81	Marr Haven 91	Unicorn Books 48
Dale of Norway 13	Martingale & Co. 7, 9, 11	Web*Sters 13
Elegant Ewe, The 91	Moco Yarns 90	Webs 86
Eucalan, Inc. ibc	Monkey Suits 79	Westminster Fibers 66
Exquisitely Angora 77	Mountain Colors 43	Wilde Yarns 78
Fiber Fantasy 72	Nancie Knits Videos 75	Wool Connection 75
Fiber Kingdom 86	Needlepoint Joint, The 48	Woolgathering Designs 93
Fiber Studio, The 90	Nordic Fiber Arts 92	Wooly West 35
Fiber Trends 86	Northwest Peddlers 77	Yarn Barn 63
Fibretech 63	Oberle, Cheryl 88	Yarn Expressions 67
Gemini Fibres 89, 92	Patternworks 48	Yarns By Design 91
General Bailey Farm 92	Personal Threads Boutique . . 43	Yarns International 53

RAVELINGS

Deanna Tobin



Rediscovering Intarsia in the Round

I KNIT LIKE A SCIENTIST, and on occasion my unorthodox approach has yielded surprising results. Take, for example, the cap pictured here, a simple rolled-edge cap with intarsia motifs. Several years ago I read somewhere that the only means to accomplish intarsia in the round is to cut the yarn at the end of each row of the motif. I was certain there was a simple way around the yarn's-at-the-wrong-end dilemma; scissors seemed like a wasteful and unwieldy method employing no creativity or knowledge of knitting structure. In short, cutting bugged me.

I cast on my navy superwash a little larger than necessary because I planned to felt the finished cap. (I know. Superwash doesn't felt. But I just have to try bucking the system once in a while.) As I worked my way around my double points, Maggie Righetti's axiom, "Purling is just knitting backwards" came to mind. I began to pay special attention to the inside face of the cap opposite the section I was knitting. Soon I came to understand that this "far side" view is the key to knitting intarsia in the round. Here's how it all fits together.

The first row of the intarsia motif is simple. Start the new color just as you would for flat knitting, weaving the main-color yarn in behind if the motif is large.

When you come around again to the motif, the contrasting yarn end is at the "wrong" end of the row. Drop the main color and turn the project 180° so that the point where you were is now farthest from you.

You are now working on the motif section from the purl side, ignoring the portion of the project nearest you. Calculate the number of stitches you need in the contrast color, and where they are going to be relative to the row below.

Transfer the stitches around the double points so that, *when viewed from the purl side*, all the stitches that need to be made in the contrasting color will be on the "left-hand" needle.

With the purl side of the fabric facing you (i.e., the inside of the hat), purl those

stitches in the contrasting color. You don't need to turn the piece inside out, unless you want to.

If you're working a large motif and don't want to leave long loops of the main color on the inside, catch up the main color strand by swinging the bobbin of contrasting yarn around it every fourth stitch or so.

Now that you're ready to resume knitting with your main color, rotate the piece



PHOTOGRAPH BY STEVE TAUBMAN.

back to its "normal" position. Transfer the stitches around the double points again so that you can resume knitting with the main color immediately following the contrasting stitches.

The next time you get around to your motif, the contrasting yarn will be avail-

able at the "beginning" and you can knit the row in the usual manner. On the row following, go "backwards" as described above, alternating knit rows and purl rows.

I subjected my finished cap to dreadful treatment in boiling soapy water followed by a bout with the clothes dryer and an old tennis shoe. No big surprise, the superwash wool stood the test and only shrank a marginal amount. But the conventional wool in the motifs felted into hard little images that narrowed the circumference. Overall, the cap was far too long and a bit too wide. I made some accordion pleats in the bottom, tacked them into place, and transformed the hat into what is best described as a celestial mushroom-cap. This quirky little item has become one of the most ridiculous members of my wardrobe.

I had earlier brought my half-knitted cap into the local yarn shop. The friendly proprietor, Lisa, and I had discovered we were both of eastern European descent. Examining my hat she remarked, "I see you're using the Bulgarian technique of intarsia in the round. Did your grandmother teach you this?" Bemused, I replied that my grandmother only taught me to crochet; the women in my family who knew how to knit all died before I was born. Lisa laughed, and we concluded that something in my upbringing had led me to recreate a technique that was likely practiced by my forebears.

On the way home, I wondered how many eastern European knitting techniques and traditions were lost in the great struggle for freedom in the first half of this century. Then I thought about the turn of history that has made me an American who enjoys the freedom and luxury of time to reinvent an age-old tradition. How my great-grandmother would smile if she knew. ∞

Taught to crochet as a child by her grandmother, Deanna Tobin picked up knitting while attending veterinary school and was often seen knitting while other students dozed off in class.

Eucalan® "No Rinse" Woolwash

We respond to hundreds of letters just like this



**Inquiries?
1-800-561-9731**

Eucalan® Woolwash contains natural lanolin and eucalyptus, which conditions the fibers while protecting against moths. Woolwash is ideal for use by hand or machine.

Dear Eucalan® Woolwash Distributor,

I absolutely adore your product, Eucalan® Woolwash.

My sister gave me a small bottle for Christmas this year, and I've been using it for all my hand knit woolen sweaters and other fine washables like silks, and cottons. I have only one problem; it's all gone! This product is amazing. I'm desperate without it!

Eucalan® Woolwash works better than any other cleanser I've ever used. It not only cleans and leaves the garment soft and fresh smelling, but the "No Rinse" feature is a godsend.

Please let me know where I can buy it locally. I look forward to your response as my laundry is piling up!

*Yours truly,
Anne McDowell*

 Eucalan® Woolwash is available from these fine stores 

Briggs & Little
Harvey, York County
506-366-5439 NB

L'Angelaine
12275 Boul. Becancour St-Angele
877-444-5702 PQ GOX 2H0

John M Hall
"The House Of Quality Linens"
519-442-4242 Paris ON

Pam's Woolly Shoppe
5301-50 St Stony Plain
888-563-1559 AB T0E 2G0

Knit 'n Stitch Shoppe W. Vancouver
2419 Marine Dr. BC V7V 1L3
800-565-KNIT www.knit-n-stitch.com

Beehive Wool Shop
2207 Oak Bay Ave. Victoria
250-598-2721 BC V8R 4G1

Textile Fiber Arts Studio
64 Paris Irons Rd. N. Scituate
401-568-7837 RI 02857

Garden City Stitches
725 Franklin Ave. Garden City
516-739-5648 NJ 11530

Patternworks
36a Southgate Dr. Poughkeepsie
800-438-5464 NY 12601

Selma's Yarn & Needlework
Heritage Inn Arcade Southbury
800-654-4341 CT 06488

Willow's End
25 Townsend Ave
800-242-YARN www.willowsend.com

Webs
Service Center Rd. Northampton
413-584-2225 MA 01061

Knitting Etc.
9980 W. 151st St. Orland Park
708-349-7941 IL 60462

Haneke Merino Wool
630 N. Black Cat Rd. Meridian
208-888-3129 ID 83642

Camp Verde Llamas & Alpacas
2487 W. Newton Lane Camp Verde
520-567-6684 AZ 86322

Norsk Engros Distributors
800-553-0014

Bryson Distributors
800-544-8992

Ten Years of Excellence with Eucalan® Woolwash 1989-1999

 **Patons**
MELODY
QUICK & COZY

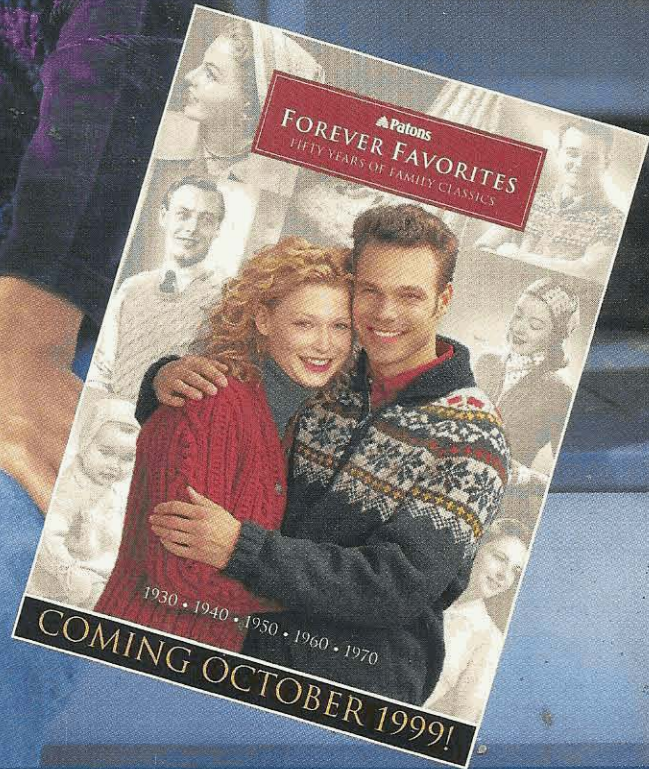
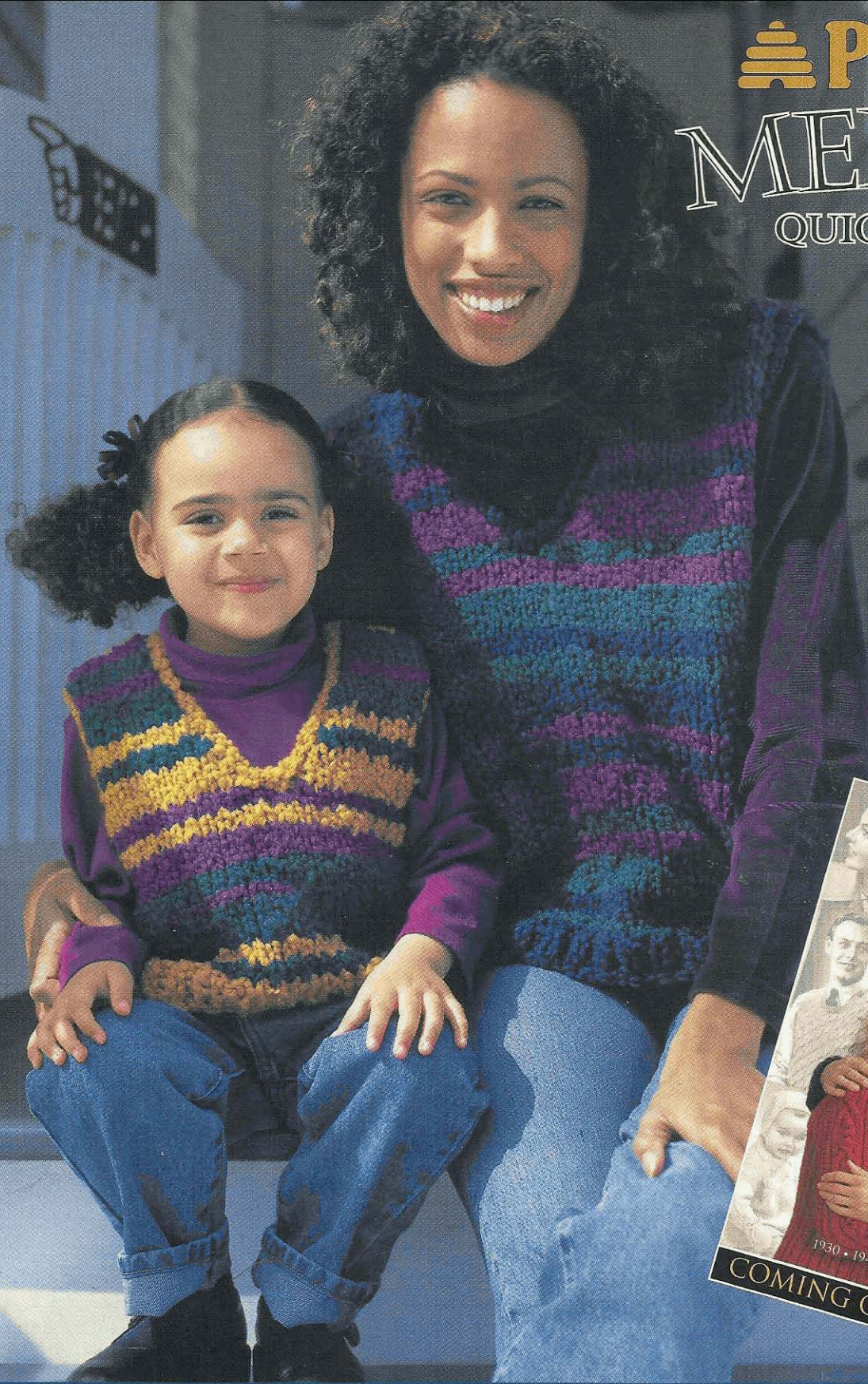

Speedy **KNITS**

 **Patons**
Patons Yarns...part of your life.

12 quick & easy knit designs available at your favorite yarn store.
Visit our website at www.coatspatons.com